

Contents

Introduction	1	Keychain Touchpad Operation	10	Installation Tips	21
Using this Manual	1	Optional Starter Kit Programming	11	To Install Smoke Sensors	22
Questions	1	To Add or Change an Access Code	11	Carbon Monoxide Sensors (CO Sensors)	22
Your CaretakerEZ Starter Kit	1	Programming Options 1 and 2	11	Installation Tips	23
Planning Your Sensor Locations	2	X-10 Lamp Module Operation	12	To Install CO Sensor	23
Power Up Control Panel	3	Time Activated Light Schedule	12	CO Sensor Operations	23
Plug in Transformer	3	Sensor Activated Lights	12	In the Event of a CO Emergency	23
Set the Clock Time	3	Entry/Exit Activated Lights	12	Freeze Sensors	23
Program Starter Kit Into Control Panel	3	Permanently Install Control Panel and Transformer	13	Installation Tips	24
Program Door/Window Sensors	3	Suggested Installation Areas	13	To Install Using Screws	24
Program Keychain Touchpad	4	Removing Control Panel From Table Base	13	To Install Using Tape	24
Program X-10 Lamp Module	4	Mounting Control Panel on Wall	13	Water Sensors	24
Programming and Setting System House Code	4	To Permanently Install Transformer	14	Installation Tips	25
Programming and Setting Unit Numbers	5	Test Your Starter Kit	14	To Install Using Screws	25
Test Programmed Devices	5	Test Sensors	14	To Install Using Tape	25
Prepare Door/Window Sensors	5	Test X-10 Lamp Module	14	X-10 Modules	25
Prepare X-10 Lamp Module	5	Adding Accessories to Your Starter Kit	15	X-10 Socket Rockets	26
Test Sensors	5	Ordering Information	15	X-10 Universal/Garage Door Modules	26
Test X-10 Lamp Module	5	Installing and Programming Additional Sensors, Modules, and Kits	16	X-10 Powerhorn Sirens	27
Install Starter Kit Devices	6	Phone/Pager Dialer	16	MaxiBlaster Exterior Hardwire Siren	27
Install Door/Window Sensors	6	To Install the Phone/Pager Dialer	16	Door/Window Sensor Hardwire Kits	28
Installation Tips	6	Programming Options 3 through 9	16	To Connect a Wireless Sensor with the Hardwire Kit	28
To Install Door/Window Sensors Using Screws	6	Phone/Pager Dialer Alarm Phone Reports	17	To Mount the Hardwire Sensor	28
To Install Door/Window Sensors Using Tape	7	Test Dialer	17	Finger Print Kits	28
Install X-10 Module	7	Remote Handheld Touchpads	18	Sensor and X-10 Module Testing	29
Install Yard Sign and Window Decals	7	Indoor Motion Sensors	19	To Test Sensors	29
Operate the System	8	Installation Tips	19	To Test X-10 Modules	29
Perform a Trial Run	8	To Install Indoor Motion Sensors	19	Battery Life and Replacement	29
Simulate an Alarm	8	Outdoor Motion Sensors	19	Troubleshooting	30-31
Bypass a Sensor	8	Installation Tips	20	X-10 Module Information Table	32
Control Panel Operation	9	To Install Outdoor Motion Sensors	20		
		Smoke Sensors	21		

CARETAKEREZ ONE YEAR LIMITED WARRANTY/30-DAY SATISFACTION GUARANTEE

We want you to be completely satisfied with our CaretakerEZ product. If you are not completely satisfied with your CaretakerEZ system, you may return it within 30 days from the date of purchase for a full refund. In order to obtain a refund, please call Technical Service at (888) 484-2896. Technical Service will provide you with the Return Merchandise Authorization Procedure. In the Return Merchandise Authorization Procedure, you will find complete instructions for returning your CaretakerEZ unit. Please follow these instructions carefully to ensure you receive proper credit.

ITI Direct, Inc. warrants that your CaretakerEZ system will be free from defects in material and workmanship for one (1) year from the date of purchase. This Limited Warranty extends only to the original purchaser and does not extend to secondary purchasers of your CaretakerEZ unit.

Our obligation under this Limited Warranty is limited to the repair or replacement, at our option, of any defective CaretakerEZ unit at no additional charge. We reserve the right to replace product under this Limited Warranty with new or remanufactured product. The repaired or replaced product is then warranted under the terms of this Limited Warranty for the balance of the term of this Limited Warranty or for ninety (90) days, whichever is longer.

This Limited Warranty does not cover batteries of any type used in connection with your CaretakerEZ unit (please refer to the battery manufacturer's warranty, if any).

We are not responsible for conditions or applications over which we have no control. Defects or problems as a result of such conditions or applications are not the responsibility of ITI Direct, Inc. Such conditions or applications include normal wear and tear, catastrophe, fault or negligence of the user or the original purchaser, improper installation, application, maintenance or use of CaretakerEZ, or other causes external to CaretakerEZ.

THE ORIGINAL PURCHASER'S EXCLUSIVE REMEDY WITH RESPECT TO ANY AND ALL LOSSES OR DAMAGES RESULTING FROM ANY CAUSE WHATSOEVER SHALL BE REPAIR OR REPLACEMENT, AS SPECIFIED ABOVE. ITI DIRECT, INC. SHALL IN NO EVENT BE LIABLE FOR ANY CONSEQUENTIAL OR INCIDENTAL DAMAGES, HOWEVER OCCASIONED, WHETHER BY NEGLIGENCE OR OTHERWISE. SOME STATES DO NOT ALLOW THE EXCLUSION OR LIMITATION OF INCIDENTAL OR CONSEQUENTIAL DAMAGES, SO THIS LIMITATION OR EXCLUSION MAY NOT APPLY TO YOU.

THE FOREGOING LIMITED WARRANTY IS IN LIEU OF ALL OTHER WARRANTIES, EXPRESS OR IMPLIED, AND NO PERSON (INCLUDING ANY AGENT, DEALER OR REPRESENTATIVE OF ITI DIRECT, INC.) IS AUTHORIZED TO MAKE ANY REPRESENTATION OR WARRANTY CONCERNING PRODUCT EXCEPT TO REFER ORIGINAL PURCHASERS TO THIS LIMITED WARRANTY. ANY IMPLIED WARRANTIES (INCLUDING, WITHOUT LIMITATION, ANY IMPLIED WARRANTIES OF MERCHANTABILITY OR FITNESS FOR A PARTICULAR PURPOSE) ARE LIMITED TO THE DURATION OF THIS LIMITED WARRANTY. SOME STATES DO NOT ALLOW LIMITATIONS ON HOW LONG AN IMPLIED WARRANTY LASTS, SO THIS LIMITATION MAY NOT APPLY TO YOU.

THIS LIMITED WARRANTY GIVES YOU SPECIFIC LEGAL RIGHTS. YOU MAY ALSO HAVE OTHER RIGHTS WHICH VARY FROM STATE TO STATE.

ITI Direct, Inc.
2266 Second Street North
North St. Paul, Minnesota 55109

Rev 10/99

Introduction

Your CaretakerEZ home security system starter kit comes complete with the components shown. You can use your security system starter kit:

- ❑ To help protect your home from intruders.
- ❑ To sound a chime whenever doors are opened letting you monitor family members coming and going.
- ❑ To control lights by using a timer to turn them on and off or by programming lights to react when doors are opened.

CaretakerEZ Panel- The “brains” of your security system that responds to wireless devices you place throughout your home.

Door/Window & Magnet Sensors- When programmed and installed, door/window sensors detect the opening of a door or window.

Door/Window & Magnet Spacers- Used to aid in installing door/window sensors when mounting surfaces are uneven.

Keychain Touchpad- Lets you to operate your security system from anywhere in your home.

X-10®Lamp Module- Allows you to control a lamp with your security system and keychain touchpad.

Window Decals & Yard Sign- Alert others that your home is protected by a security system.

9VAC Transformer- The primary power supply for your control panel. The transformer is attached to your control panel.

9V Lithium Battery- The backup power supply for your control panel during an AC power failure (located in control panel).

Note

If you purchased additional accessories with your starter kit, install them *after* setting up the starter kit.

Using This Manual

This manual has been specifically designed and user tested for ease of use. Carefully following the instructions will make installing your system an easy process. This manual is divided into three sections:

- ❑ The first section, “Your Starter Kit,” will guide you through powering up, programming, installing, operating, and testing your starter kit.
- ❑ The second section, “Additional Accessories,” will introduce you to accessories you can purchase to add functions and additional security to your starter kit.
- ❑ The third section, “Tables & Forms,” contains troubleshooting information for both the starter kit and additional accessories.

Questions?

If you have questions about programming, installing, or using your CaretakerEZ system, or if you want to order additional accessories, please call CaretakerEZ Customer Assistance toll-free at 888-484-2896 Weekdays 7 a.m. - 8 p.m. Central Time or visit us on the web at www.ezsecurity.com

Your CaretakerEZ Starter Kit

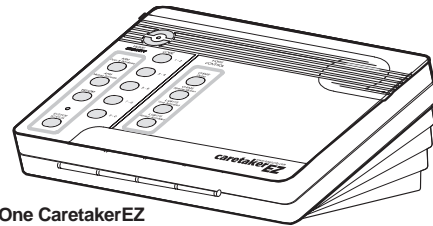

One CaretakerEZ Control Panel

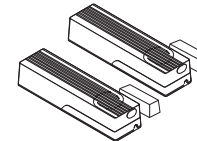

Two Door / Window & Magnet Sensors (part no. 60-670-01-43)

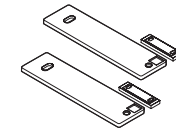

Two Sets Door / Window & Magnet Spacers (part no. 60-827)



One Keychain Touchpad (part no. 60-694-01-43)



One X-10 Lamp Module (part no. 13-403)

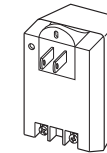

One 9VAC Transformer (part no. 22-091-IT1)

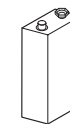

One 9V Lithium Battery (part no. 34-037)



Two Window Decals (part no. 422-2174)



One Yard Sign (part no. 422-2173)

Hardware		
Each individual piece comes with the following:		
Control Panel	Door/Window Sensor	Door/Window Spacers
Two # 8 Sized Screws	Four Short #4 Sized Screws	Four Long #4 Sized Screws
Two Wall Anchors	One Square of Double Sided Tape	

Planning Your Sensor Locations

Use this form to plan your sensor locations and record the sensor type programmed into the control panel at each location. Sensor location names may be used more than once. For example, if you place more than one door/window sensor in your basement, your control panel can identify the first door/window sensor “Basement 1, Sensor.” The second door/window sensor can be identified “Basement 2, Sensor.” See examples 1 and 2.

Available Sensor Names

When programming sensors into your control panel, the panel voice announces all possible sensor names in the following order:

Keychain Remote, Touchpad Remote, Front Door, Back Door, Garage Door, Bedroom, Guest Room, Child’s Room, Utility Room, Living Room, Dining Room, Bathroom, Laundry Room, Kitchen, Office, Den, Garage, Special Chime, Basement, Upstairs, Downstairs, Hallway, Medicine Cabinet, Closet, Attic.

Available Sensor Types

Keychain Touchpad, Handheld Touchpad, Door/Window Sensor, Indoor Motion Sensor, Outdoor Motion Sensor, Smoke Sensor, CO Sensor, Freeze Sensor, Water Sensor.

Sensor Programming Form

Sensor Name	Sensor Type	Notes
(Ex. 1) <i>Basement 1</i>	<i>Door/Window Sensor</i>	<i>Sensor on west basement window</i>
(Ex. 2) <i>Basement 2</i>	<i>Door/Window Sensor</i>	<i>Sensor on east basement window</i>
(Ex. 3) <i>Upstairs Smoke</i>	<i>Smoke Sensor</i>	<i>Smoke sensor in upstairs hallway</i>
(Ex. 4) <i>Downstairs Smoke</i>	<i>Smoke Sensor</i>	<i>Smoke sensor in downstairs hallway</i>
1.		
2.		
3.		
4.		
5.		
6.		
7.		
8.		
9.		
10.		
11.		
12.		
13.		
14.		
15.		
16.		
17.		

1. Power Up Control Panel

Place your control panel on a table or convenient location to become familiar with your security system and program the starter kit. You will place the control panel in a permanent location later. The control panel will retain all programming information (except for the time) if the battery is removed.

A. Plug in Transformer

1. Remove the screw and washer from the transformer and set them aside for later use.
2. Plug the transformer into the outlet. The control panel will beep and announce *Hello. System is OK.*

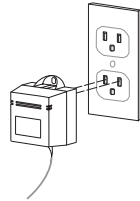

3. Open the panel cover by pressing the tab and lifting. The control panel will announce *Please select from start menu.* Disregard this statement for now.

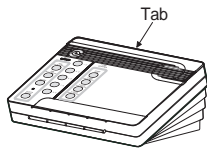

4. Attach the supplied 9V battery (located inside cover).

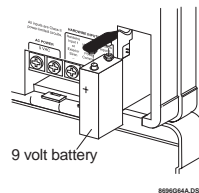

B. Set the Clock Time

Set the clock to the current time. You should also reset the clock at daylight savings time changes and whenever both AC and battery power are lost.

To set or change your clock time:

1. **Open control panel cover.**
 2. **Press Clock Set** button under START MENU.
 3. **Press Hour** button under MAIN MENU until you hear the correct hour setting.
 4. **Press Minute** button under MAIN MENU until you hear the correct minute setting.
 5. **Press DONE** button.
- Panel voice announces the time you set.
6. **Close control panel cover.**

2. Program Starter Kit Devices Into Control Panel

Each sensor and touchpad has a unique electronic ID number that your control panel must learn via programming in order to recognize signals from individual devices. Follow the instructions below to program each device in your starter kit. If you make a mistake, simply follow the instructions to delete the programmed device and re-program it into the control panel. **To place the control panel into program mode, open the cover.**

Note

The panel will beep six times and announce *Please select from start menu* every minute the control panel cover is open. To stop this announcement close the control panel cover.

Programming for sensors and touchpads follows a basic sequence:

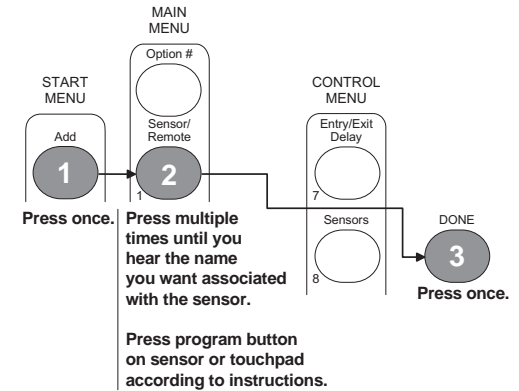

A. Program Door/Window Sensors

When programmed and installed, door/window sensors detect the opening of a door or window. If your system is armed and a protected door is opened, unless the system is disarmed within 30 seconds, an alarm will sound. If a protected window is opened, an intrusion alarm will sound immediately. **There are two door/window sensors in your starter kit.** Programming instructions continued on next page.

To program door/window sensors into control panel:

1. **Open control panel cover** (if not already open).
2. **Remove cover** from door/window sensor by pressing cover release button and lifting cover off.

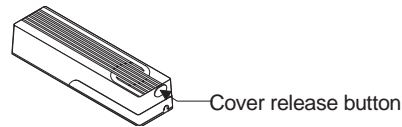

3. **Press Add** button from START MENU.
4. **Press Sensor/Remote** button from MAIN MENU until you hear the panel announce the name you want associated with the sensor.
5. **Press "Press to Program"** button on sensor.

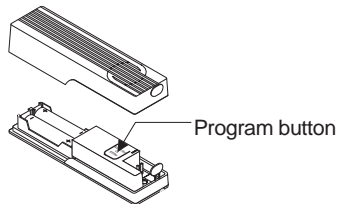

Panel voice announces *<Sensor name> programmed.*

6. **Label the sensor** (with the programmed name) using tape and a pen.
7. **Write sensor information** in form [on page 2](#).

To delete door/window sensors from control panel:

1. **Open control panel cover.**
 2. **Press Delete** button from START MENU.
 3. **Press Sensor/Remote** button from MAIN MENU until you hear the name of the sensor you want to delete.
 4. **Press DONE** button.
- Panel voice announces *<Sensor name> deleted.*
5. **Close control panel cover.**

B. Program Keychain Touchpad

Besides the control panel touchpad, you can use remote touchpads to operate, but not program, your security system from any location within or near your home. **There is one keychain touchpad in your starter kit.**



To program keychain touchpad into control panel:

1. **Open control panel cover** (if not already open).
2. **Press Add** button from START MENU.
3. **Press Sensor/Remote** button from MAIN MENU until you hear keychain remote.
4. **Press Star** button on keychain touchpad until the small light on the keychain flashes.

Panel voice announces *Keychain remote sensor programmed.*

To delete keychain touchpad from control panel:

Note

If you lose your keychain touchpad, delete it from your control panel immediately so it cannot be used to operate your security system by someone who finds it.

1. **Open control panel cover.**
2. **Press Delete** button from START MENU.
3. **Press Sensor/Remote** button from MAIN MENU until you hear the panel announce Keychain remote sensor.
4. **Press DONE** button.

Panel voice announces *Keychain remote sensor deleted.*

5. **Close control panel cover.**

C. Program X-10® Lamp Module

Note

Discard any instructions that come in the X-10 module box.

X-10 lamp modules can be plugged into outlets allowing you to control lamps with your security system. When your system is armed and an intrusion is detected, all system-controlled lights will flash to signal an intrusion alarm. Lamps connected to lamp modules flash for five minutes upon intrusion detection. After five minutes, if the system has not been disarmed, the lights quit flashing and remain on. These lamps will turn on and remain on to signal a fire alarm or other emergency even if your system is not armed. Use the X-10 Module Information Table [on page 32](#) for keeping track of X-10 Modules and settings. **There is one X-10 lamp module in your starter kit.**

Programming and Setting System House Code

All X-10 lamp modules use a common house code that can be identified by your control panel. The house code you set on your lamp modules must be the same as the house code you program into your control panel.

To program house code into control panel:

Note

Do not use house code "P" for lamp modules. "P" is reserved for X-10 power-horn siren accessories. Since other security systems may use similar modules, it is best to use a house code other than "A" to avoid possible interference from neighboring security systems.

1. **Open control panel cover** (if not already open).
2. **Press Add** button from START MENU.
3. **Press Light Control** button from MAIN MENU until you hear the house code letter (B-O) you want.
4. **Press DONE** button.

Panel voice announces *House code is <code you set>.*

To set house code on X-10 lamp modules

Use a screwdriver to set the house code on each X-10 lamp module to the same one you programmed into the control panel.

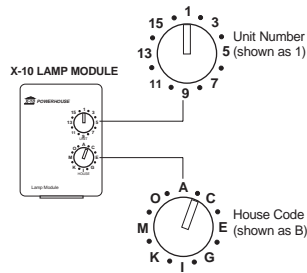

Programming and Setting Unit Numbers

The X-10 lamp modules also use unit numbers which allow you to program individual lights or groups of lights to go on and off at scheduled times or during the entry/exit delay.

To set unit numbers on X-10 lamp modules:

1. Use a screwdriver to set the unit number you want on each module. Use the same unit number for all of the lights you want to operate as a group. Create different lighting “zones” using groups of lights with the same unit number.

3. Test Programmed Devices

Once you have programmed the door/window sensors, keychain touchpad, and X-10 lamp module, it is a good idea to test them before installing. This will ensure that everything works properly.

A. Prepare Door/Window Sensors

1. Assemble the door/window sensor magnets by pressing the magnets into the plastic magnet covers.

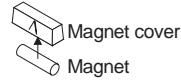

2. On a flat surface such as a table, line up the arrow on a magnet with the arrow on a sensor. Make sure that there is no more than a 3/8-inch gap between the magnet and sensor.

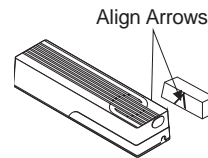

3. Repeat steps 1 and 2 for the other door window sensor.

B. Prepare X-10 Lamp Module

Caution

Do not plug appliances into X-10 lamp modules. Do not use X-10 lamp modules with lamps that use over 300 watts. Use module with incandescent lamps only.

1. Plug lamp module into non-switch controlled outlet.
2. Plug lamp into module, leave lamp switch on.

C. Test Sensors

1. Open the control panel cover.
2. Press the Sensor Test button once from the START MENU. The panel announces, one at a time, the sensors you have programmed. As you test them the control panel will announce <Sensor name> sensor OK. After all sensors have been successfully tested the control panel will announce Sensor test OK.
3. Test the door/window sensors by pulling the magnets away from each sensor.

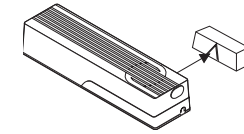

4. Test the keychain remote by pressing and holding the red Emergency button on the keychain touchpad for three seconds.

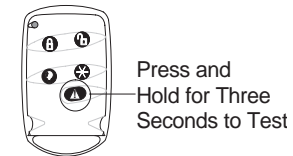

5. Close the control panel cover.

D. Test X-10 Lamp Module

1. Ensure that the lamp module works by pressing the Lights button on the keychain touchpad until the small light on the keychain flashes. The lamp should turn on. Press the Lights button on the keychain touchpad a second time to turn the lamp off.

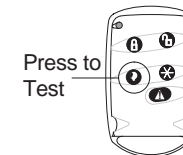

4. Install Starter Kit Devices

A. Install Door/Window Sensors

Installation Tips

- ❑ **Screw installation is recommended.**
- ❑ When possible, place the magnet on the moving part of the door or window.
- ❑ Make sure that sensor cover release button is accessible so batteries can be replaced.
- ❑ Use the Sensor Programming Form on page 2 to help you plan sensor locations.
- ❑ Place sensors as high as possible to prevent sensors from being bumped out of position or damaged.
- ❑ Avoid mounting sensors in areas with a high concentration of metal or electrical wiring.

Note

If sensor and magnet mounting surfaces are uneven (for example, the frame is not flush with the door), use the spacers provided to “build up” the low side so that sensors and magnets are at the same level. When installing with spacers, you must use the longer screws provided to mount sensor and magnet. Most importantly, make sure that the marks on both the sensor and magnet are aligned within 3/8-inch gap of one another.

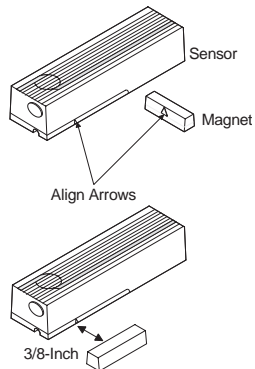

Examples:

Standard Door and Window

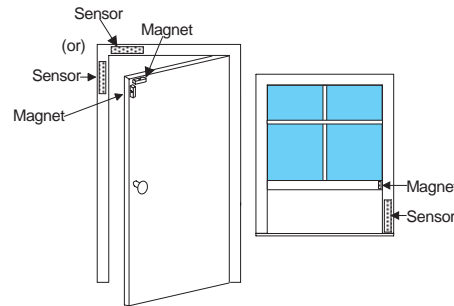

Sliding Glass Door

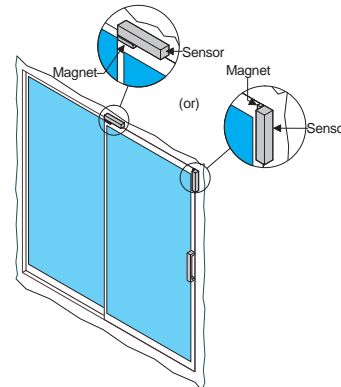

Double Hung Window

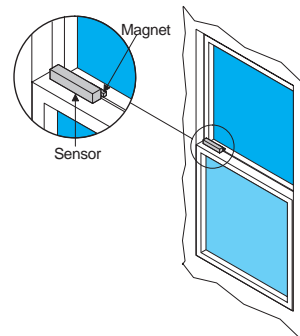

Casement (crank out) Window

Note

You may need to remove the screen to install the door/window sensor. Do not place sensor on crank out window. For certain style casement windows you may need to use the door/window hardware kit accessory. (See page 15 for more information.)

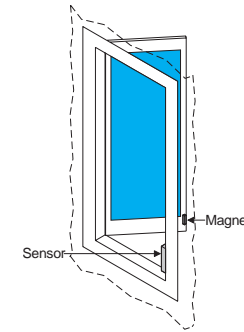

To Install Door/Window Sensors Using Screws:

1. Remove sensor cover by pressing the button on the end.
2. Remove batteries to access mounting holes.
3. Position the sensor, then center the magnet base across from the embossed mark on the sensor. Mark screw locations for both the sensor and the magnet.

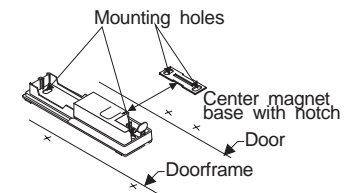

4. Install Starter Kit Devices

- Use a 3/32-inch sized drill bit to drill 1/2-inch deep holes where you made the marks.

Note

It is not necessary to drill holes before installing however, it may prevent cracking of woodwork.

- Secure the sensor base and magnet base within 3/8-inch of one another using the short #4 screws provided.

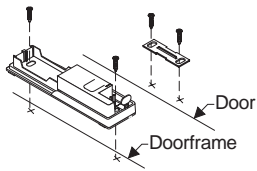

- Snap magnet cover (with magnet inside) onto magnet base.

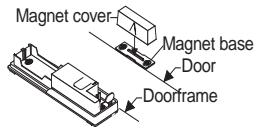

- Replace sensor batteries and cover.

To Install Door/Window Sensors Using Tape:

Caution

Mount sensors with screws whenever possible. The tape provided is very aggressive. It may pull off wallpaper, paint, and woodwork finish when removed.

- Using a pair of scissors, cut a 1/4-inch piece off of the double sided tape. This piece will be used to mount the magnet.
- Rotate the remaining tape 90° and cut in half making two 5/8-inch pieces. These pieces will be used to mount the sensor.

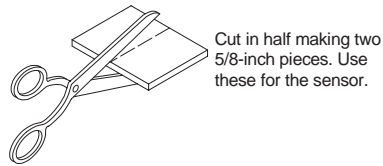
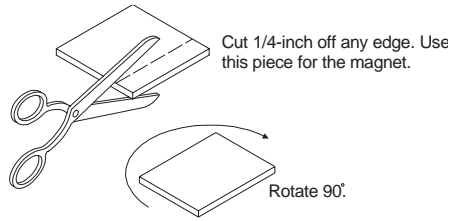

- Apply the two 5/8-inch pieces of tape to sensor.

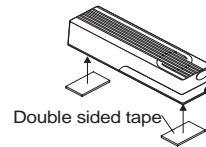

- Snap magnet cover (with magnet inside) onto magnet base. Apply 1/4-inch piece of tape.

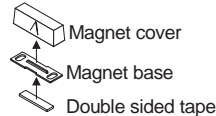

- Line up the arrow on the magnet with the arrow on the sensor base.
- Secure magnet and sensor to a clean dry surface making sure that the arrows on the magnet and sensor are within 3/8-inch of one another.

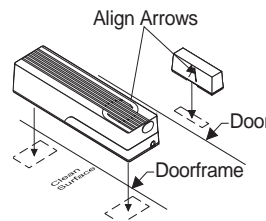

B. Install X-10 Module

Caution

Do not plug appliances into X-10 lamp modules. Do not use X-10 lamp modules with lamps that use over 300 watts. Use module with incandescent lamps only.

- Plug module into non-switch controlled outlet.
- Plug lamp into module, and leave lamp switch on.
- Make sure that the module works (and that the lamp is on) by pressing the Lights button on the keychain touchpad (see page 10). The lamp should turn on. Press the Lights button on the keychain touchpad a second time to turn the lamp off.

C. Install Yard Sign and Window Decals

Displaying signs and decals alerting others that your home is protected by a security system is your first level of defense against would-be intruders. **There is one yard sign and two window decals in your starter kit.**

- Place the yard sign in a visible area in your yard and attach the decals so they are visible on outside doors and windows to help deter potential intruders from entering your home.



5. Operate the System

Once you have programmed and installed the devices in your starter kit, you are ready to begin using your new system.

To attain the highest level of protection from your security system, follow these basic guidelines:

- Remember to close all open windows and doors before you arm the system (unless you want those doors or windows bypassed, which means they are not protected).
- Arm your system and exit before the 30-second exit delay expires. The exit delay is the time allowed to exit the premises after arming your system.
- Disarm your system within the 30-second entry delay when you return. The entry delay is the time allowed to disarm your system after entering the premises before the system goes into alarm.
- Respond to beeps, light indicators, and voice announcements from your system that may indicate some type of problem.

Warning!

If you enter your home and:

- **system controlled lights that are normally off are on and/or flashing or,**
- **you hear alarm sirens or,**
- **your SYSTEM STATUS light is flashing,**

an intruder may be inside or another emergency has occurred. For your protection, leave immediately and call for help from another location.

If the SYSTEM STATUS button is lit, press the SYSTEM STATUS button to hear the current status.

Perform a Trial Run

Perform a “trial run,” to help you become familiar with using your home security system.

Arm System and Exit

1. Close all protected doors and windows.
2. Press the ARM Door & Windows button on the control panel. The button will light and the panel will announce *Doors and windows on*.
3. Exit the premises within the 30 second exit delay. Once the exit delay has expired enter and disarm the system as described below.

Enter and Disarm System

1. Enter the premises through a protected door.
2. Press the DISARM button on the control panel within the 30 second entry delay. The button will light and the panel will announce *System disarmed*.

Simulate an Alarm

Simulate an alarm so that you become familiar with how your system behaves during an alarm.

1. Close all protected doors and windows.
2. Press the ARM Door & Windows button on the control panel. The button will light and the panel will announce *<Any open sensors>, doors and windows on*.
3. Allow the exit delay to expire.
4. Open a protected window (causing an instant alarm) or door (wait for the entry delay to expire) forcing the system into alarm.

Once the system goes into alarm:

- The system siren will beep once every second.
- System controlled lights flash for five minutes. After five minutes (if the system has not been disarmed) the lights quit flashing and remain on.
- The SYSTEM STATUS button on the control panel will start blinking.

5. Press the DISARM button to cancel the alarm.
6. Press the SYSTEM STATUS button for details about the alarm condition.

Bypass a Sensor

If any doors or windows are open when the system is armed, they will be automatically bypassed after the exit delay expires. These sensors will not provide security protection. Bypass a sensor so that you can become familiar with this feature.

1. Open a protected door or window.
2. Press the ARM Door & Windows button on the control panel. The button will light and the panel will announce *<Sensor name> open, doors and windows on*.
3. Allow the exit delay to expire.
4. Open and close the bypassed door or window.

Notice that the system doesn't react when the door or window is opened and closed.

5. Press the DISARM button when finished.

Complete Operation Descriptions

The diagram on the following page describes each panel button function for system operation. Additional programming options that you can do with your starter kit are described [on page 11](#).

5. Operate the System

ARM Doors & Windows

Press this button once to turn security system protection on for all doors and windows with sensors. The button lights and the panel voice announces *<Any open sensors>*, beeps, then says, *Doors and windows on*. The 30-second exit delay begins now. **If any doors or windows are open when the system is armed, they will be automatically bypassed after the exit delay expires. These bypassed sensors will not provide security protection.**

ARM Motion Sensors

Press this button once to turn protection on for all intrusion motion sensors.* The button lights and the panel voice announces *<Any open sensors>*, beeps, then announces *Motions on*. The 30 second delay begins now. Arm motion sensors in areas where pets are not kept. Close windows in areas with an armed indoor motion sensor. **Press this button twice** to enable the latchkey feature.**

*Requires indoor motion sensor accessory. See page 15 to order.
**Requires dialer accessory. See page 15 to order.

CHIME Doors

Press this button once to enable the control panel to beep when protected doors or windows are opened and the system is not armed. The button lights and the panel voice announces *Chime on*. This will allow you to monitor family members coming and going.

CHIME (Special Motion)

Press this button to enable the control panel to beep when motion sensors* or door/window sensors programmed as *Special Chimes* are triggered. The button lights and the panel announces *Special chime on*. *Special Chime* motion sensors are used, for example, to let you know if someone enters a pool area. This special chime feature allows you to monitor traffic, but does not provide intrusion protection.

*Requires motion sensor accessory. See page 15 to order.

LIGHTS (Time Activated)

Press this button to enable a time-activated light schedule (see page 12). The button lights and the panel announces *Time activated lights on*. For example, press this button after programming your system to turn your living room lights on at 7 p.m. and off at 10 p.m.*

*Your system clock must be set.

LIGHTS (Sensor Activated)

Press this button to have system-controlled lights turn on for four minutes when sensors are tripped. The button lights and the panel announces *Sensor activated lights on*. For example, use a door/window sensor at the front door and set an X-10 lamp module to be activated by it. When the door opens the X-10 lamp module will turn on the light.

SYSTEM STATUS

Press once to hear time, open sensors, and any system problems* (including any low batteries). **Press twice** to hear the programmed sensor names, house code, light controls, and programming options. If a phone/pager dialer accessory is installed, the system also informs you about your programmed phone numbers and your recorded message.

*See Troubleshooting Table for system problem solutions.

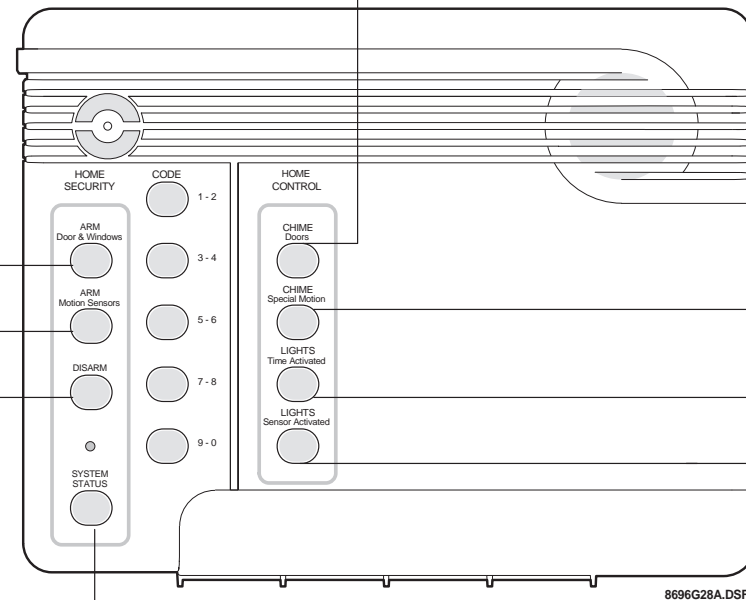

DISARM

Press this button once to turn off security protection. The button lights, the panel beeps, and announces *System disarmed*, signaling that the system is disarmed.

Keychain Touchpad Operation

When using a keychain touchpad, press and hold the desired button until the keychain indicator light blinks.

Lock

Press this button once to arm doors and windows. The panel voice announces *<Any open sensors>*, beeps, then announces *Doors and windows on*. The 30-second exit delay begins now. **Press this button twice** to arm the door, windows, and motion sensors.* The panel voice announces *<Any open sensors>*, beeps, then says *Motions on*. The 30-second delay begins now. **Press this button three times** to arm doors, windows, motion sensors*, and to activate the latchkey feature.** The panel voice announces *<Any open sensors>*, beeps, then says *Latchkey on*. The 30-second delay begins now.

*Requires motions sensor accessory. See page 15 to order.
**Requires dialer accessory. See page 15 to order.

Lights

Press this button to turn all lights controlled by X-10 modules on or off.

Keychain Indicator Light

Blinks to indicate that a signal has been sent to the control panel.

Unlock

Press this button to disarm the security system or cancel an alarm. The panel beeps and announces *System disarmed*, which signals that the system is disarmed.

Star

Press this button to open or close your garage door* or turn on lights for four minutes. Lights must be programmed as sensor activated lights.

*Requires X-10 universal/garage door module. See page 15 to order.

Emergency

Press this button and hold for three seconds to sound alarms, turn on controlled lights, and dial pre-programmed phone numbers.* The panel siren beeps rapidly and system controlled lights turn on. Press the unlock button (or disarm the system) to cancel emergency alarm.

*Requires dialer accessory. See page 15 to order.

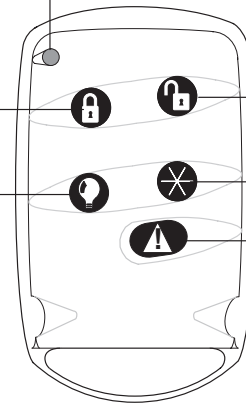

Optional Starter Kit Programming

Your CaretakerEZ starter kit has a number of other features you can program according to your needs. For operation highlights, see the Quick Reference Table on the back cover of this manual or refer to the decals on the inside of the control panel cover.

To Add or Change an Access Code:

Your security system arrives without a programmed access code, and it is not necessary to program and use an access code. However, for a higher level of protection, it is recommended that you program an access code using a four-digit number you can easily remember but won't be easy for an outsider to guess or press at random.

To add or change an access code:
1. Open control panel cover.
2. Press Add button under START MENU.
3. Press Access Code button under MAIN MENU.
4. Enter 4 numbers using the red numbered keys.
Panel voice announces <i>Access code is ####.</i>
5. Close control panel cover.

To delete an access code:
1. Open control panel cover.
2. Press Delete button under START MENU.
3. Press Access Code button under MAIN MENU.
Panel voice announces <i>Access code deleted.</i>
4. Close control panel cover.

Programming Options 1 and 2

Option 1-Disable Panel Siren

- When you **Add Option 1**, you are disabling or turning **off** the panel siren and panel beeps (alarm sirens will still sound from an X-10 power-horn and/or MaxiBlaster siren if installed).
- When you **Delete Option 1**, you are turning the control panel siren and beeps back **on**.

Option 2-Disable Voice

- When you **Add Option 2**, you are disabling or turning **off** the panel voice (except for voice prompts when in program mode, status messages, and open sensor responses).
- When you **Delete Option 2**, you are turning the panel voice back **on**.

To delete Option 1 or 2:
1. Open control panel cover.
2. Press Delete button under START MENU.
3. Press Option # button under MAIN MENU.
4. Press DONE button to delete Option 1 (which turns the panel siren on).
or
Press Option # button again, then Press DONE button to delete Option 2 (turn panel voice on).
Panel voice announces <i>Option # deleted.</i>
5. Close control panel cover.

To program Option 1 or 2:
1. Open control panel cover.
2. Press Add button under START MENU.
3. Press Option # button under MAIN MENU.
Panel voice announces <i>Option 1, press again for next option or done to select.</i>
4. Press DONE button to turn Option 1 on (which turns the panel siren off).
or
Press Option # button again, then Press DONE button to turn Option 2 on (which turns the panel voice off).
Panel voice announces <i>Option # is on.</i>
5. Close control panel cover.

X-10 Lamp Module Operation

To add time-activated light schedule:

A time activated light schedule will enable your system to turn on and off X-10 module controlled lights according to a schedule you decide.

1. **Open control panel cover.**
2. **Press Add** button from START MENU.
3. **Press Light Control** button from MAIN MENU.
4. **Press Unit #** button until you hear the unit number you set on the X-10 lamp module(s).
5. **Press Time** button from CONTROL MENU.
6. **Press Hours** and **Minutes** buttons to set the start time (when lights turn on).
7. **Press DONE** button.
8. **Press Hours** and **Minutes** buttons to set the stop time (when lights turn off).
9. **Press DONE** button.

Panel voice announces *Unit number X start time X:XX; stop time X:XX.*

10. **Close control panel cover.**
11. **Press LIGHTS Time Activated** button on the front of the control panel to enable the time-activated feature.
12. **Write light schedule information** into table on page 32.

Note

The system clock must be set for feature to work correctly. Use different lamp modules with different unit numbers to set multiple light schedules.

To delete time-activated light schedule:

1. **Open control panel cover.**
2. **Press Delete** button from START MENU.
3. **Press Light Control** button from MAIN MENU.
4. **Press Unit #** button until you hear the unit number you want to delete.
5. **Press Time** button from CONTROL MENU.

Panel voice announces *Unit number X, time-activated lights deleted.*

6. **Close control panel cover.**

To add a sensor-activated light:

Sensor activated lights turn on, and remain on for four minutes when specified sensors are tripped.

1. **Open control panel cover.**
2. **Press Add** button from START MENU.
3. **Press Light Control** button from MAIN MENU.
4. **Press Unit #** button until you hear the number you set on the X-10 lamp module(s) you want activated when a sensor is activated.
5. **Press Sensors** button from CONTROL MENU until you hear the panel announce the name of the sensor you want to control the sensor-activated light(s).
6. **Press DONE** button.

Panel voice announces *Unit number X activated by <name of sensor>.*

7. **Close control panel cover.**
8. **Press LIGHTS Sensor Activated** button on the front of the control panel to enable the sensor-activated feature.
9. **Write sensor activation information** into table on page 32.

Note

You can use the sensor-activated light function to assign a keychain touchpad to an X-10 unit number. Then, for example, you can use the star button on your keychain touchpad to open and close your garage door using the X-10 universal/garage door module and your existing garage door opener (see page 15 to order).

To delete a sensor-activated light:

1. **Open control panel cover.**
2. **Press Delete** button from START MENU.
3. **Press Light Control** button from MAIN MENU.
4. **Press Unit #** button until you hear the unit number you want to delete.
5. **Press Sensors** button from CONTROL MENU until you hear the name associated with the sensor activated light you want to delete.
6. **Press DONE** button.

Panel voice announces *Unit number X activated by <name of sensor> deleted.*

7. **Close control panel cover.**

To add entry/exit-activated lights:

Entry activated lights turn on when you trip a specified door/window sensor and turn off when you disarm the control panel.

1. **Open control panel cover.**
2. **Press Add** button from START MENU.
3. **Press Light Control** button from MAIN MENU.
4. **Press Unit #** button until you hear the number you set on the X-10 lamp module(s) you want to activate during the delays.
5. **Press Entry/Exit Delay** button from CONTROL MENU.

Panel voice announces *Unit number X activated by entry or exit delay.*

6. **Close control panel cover.**
7. **Write entry/exit information** into table on page 32.

Note

Entry/exit-activated lights will turn on for the 30 second delay period when exiting your house. Entry/exit-activated lights will turn off when you disarm your system after entering your house.

To delete entry/exit-activated lights:

1. **Open control panel cover.**
2. **Press Delete** button from START MENU.
3. **Press Light Control** button from MAIN MENU.
4. **Press Unit #** button until you hear the unit number you want to delete.
5. **Press Entry/Exit Delay** button.

Panel voice announces *Unit number X activated by entry or exit delay deleted.*

6. **Close control panel cover.**

To control individual X-10 modules:

You need the handheld touchpad accessory. See page 15 for ordering information.

6. Permanently Install Control Panel and Transformer

Note

You may leave your control panel on the base OR mount it on a wall.

Suggested Installation Areas

- ❑ Place your control panel where you can hear the panel siren and voice throughout your home.
- ❑ Do not put your control panel near windows or doors where it can be easily reached by an intruder.
- ❑ Place control panel within a few feet of a telephone jack (if you have purchased the phone/pager dialer accessory) and an electrical outlet that is not controlled by a wall switch.
- ❑ Place your control panel where metal objects, including mirrors and metallic wallpaper, do not block the signals sent by your wireless sensors.

Your control panel is attached to a table base allowing you to place the unit on a table or desk to operate your system. Depending on where your control panel will work best in your home, you may want to remove the table base and mount the control panel on a wall.

To Remove Your Control Panel From the Table Base (If Wall Mounting):

1. Open control panel cover by pressing tab and lifting.

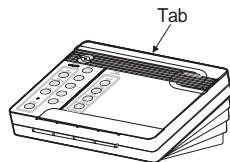

2. Remove battery from panel and unplug transformer from wall.

Note

You will need to reprogram the time once you power up the panel. All other programming and settings will remain.

3. Loosen screws two turns each.

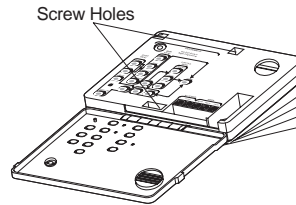

4. Slide the base along the back of the control panel and pull the control panel away from the base.

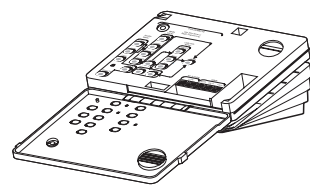

2. Start holes using screw tip or a nail (tap optional wall anchors into holes if necessary).

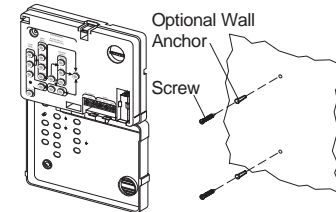

3. Turn the screws in part way and slide the control panel onto the screws, then tighten the screws the rest of the way.

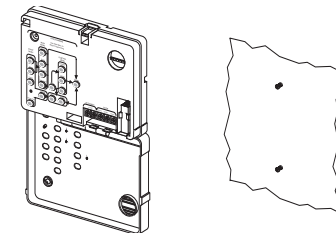

To Mount Your Control Panel on a Wall (Optional):

1. Position the control panel on the wall. Mark screw hole locations through mounting holes.

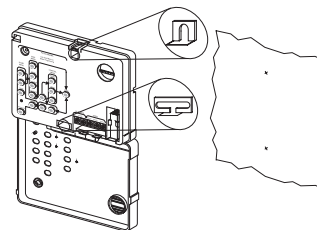

A. Permanently Install Transformer

Warning!

If the outlet has a metal cover plate, do not let the metal cover plate fall (when replacing screw) onto the two transformer prongs. Doing so may shock you and will damage the transformer. Use electrical or masking tape (do not use duct tape) as shown, to tape the cover to the wall before performing the procedure below.

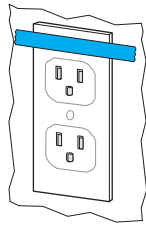

Caution

Do not plug transformer into a ground fault outlet or an outlet controlled by a switch.

1. Remove the existing screw from the center of the outlet and discard.

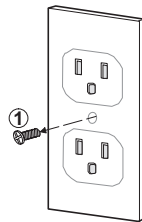

2. Plug transformer into the outlet.

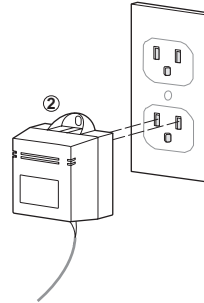

3. Use the transformer screw (you removed from transformer earlier) to secure transformer to outlet.

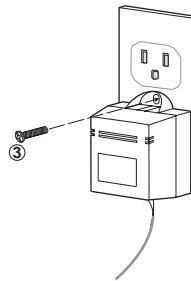

7. Test Your Starter Kit Devices

Now that you have programmed and installed your starter kit, and have chosen a permanent location for your control panel, perform a test to ensure that all sensors and modules communicate with the panel.

A. Test Sensors

1. Open control panel cover.
2. Press Sensor Test button once from START MENU. The panel announces, one at a time, the sensors you have programmed.

3. “Trip” sensors one at a time. You can trip them in any order; you do not have to trip sensors in the order the control panel announces them. When you trip a sensor and it communicates successfully, that sensor will be removed from the announced list. See the table below for sensor tripping instructions. Panel voice announces *Sensor test OK* after all sensors have been successfully tested.
4. Press DONE button if any sensors did not test successfully or you want to terminate the test. The panel voice announces *Sensor test canceled or failure*. If a sensor test fails, see the **Troubleshooting Table** in the back of this manual.
5. Close control panel cover.

Note

See [page 29](#) for a more complete sensor testing table.

B. Test X-10 Lamp Module

1. See the “X-10 Module” section in the table below for module testing instructions.

Starter Kit Testing Table

Sensor	Do This to Trip Sensor(s)
Door/Window	Open the door or window you want to test.
Keychain Touchpad	Press and hold the red button for 3 seconds on the keychain touchpad you want to test.
X-10 Module	
X-10 Lamp Module	Press and hold the Lights button on the keychain touchpad. The light should turn on/off.

Adding Accessories to Your Starter Kit

There are several optional devices available which allow you to add even more functionality to your CaretakerEZ system. Depending on your needs, you may want to install several of these additional components.

Starter Kit Accessories- You may order additional keychain touchpads, door/window sensors, and X-10 lamp modules.

Phone/Pager Dialer- Enables your CaretakerEZ panel to send alarm messages to pre-programmed phone or pager numbers that alert you when you are away.

Remote Handheld Touchpads- Allow you to operate your security system and control individual system lights from anywhere in your home.

Indoor Motion Sensors- May be used for intrusion protection or to sound a special chime from the control panel.

Outdoor Motion Sensors- May be used to detect motion in outdoor areas and sound a special chime or turn on sensor activated lights.

Smoke Sensors- Provide warning of a fire by sounding sirens and turning on system controlled lights.

Carbon Monoxide (CO) Sensors- Provide early warning of dangerous carbon monoxide gas levels.

Freeze Sensors- Alert you to a furnace failure before pipes freeze.

Water Sensors- Alert you to rising water or leaks to minimize damage to your home.

X-10 Modules- Allow you to control lights inside or outside your home, operate your garage door, and use remote sirens.

MaxiBlaster Exterior Hardwire Siren- A very loud exterior siren that alerts you to a potential problem in your home and scares off would-be intruders.







Door/Window Sensor Hardwire Kit- Allows you to mount door/window sensors in less visible areas.

Fingerprint Kit- Helps safeguard children and family in the event of an emergency.

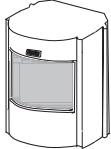
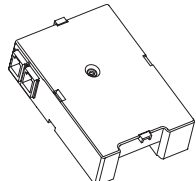
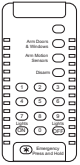
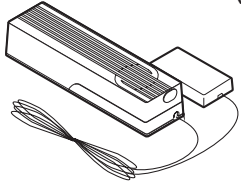
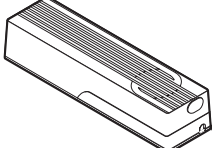
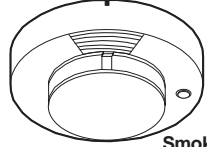
Ordering Information

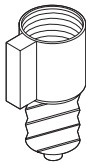
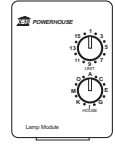
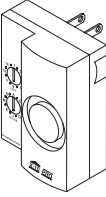
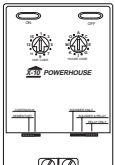
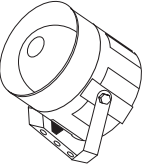
To order any of the additional components shown here please call CaretakerEZ Customer Assistance toll-free at 888-484-2896, weekdays 7 a.m. - 8 p.m. Central Time, or visit us on the web at www.ezsecurity.com

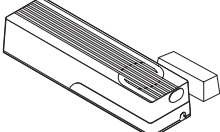
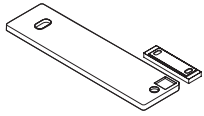
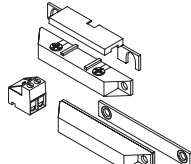
Additional Accessories

 Indoor Motion Sensor (part no. 60-639-01-43)	 Outdoor Motion Sensor (part no. 60-639-43-01-OD)	 Phone/Pager Dialer (part no. 60-666-01)	 Remote Handheld Touchpad (part no. 60-671-43)
 Water Sensor (part no. 60-744-01-43)	 Freeze Sensor (part no. 60-742-01-43)	 Smoke Sensor (part no. 60-668-01-43)	
 Carbon Monoxide Sensor (part no. 60-652-43)	 X-10 Socket Rocket Module (part no. 13-461)	 X-10 Lamp Module (part no. 13-403)	 X-10 Powerhorn Wireless Siren (part no. 13-398)
 X-10 Universal/Garage Door Module (part no. 13-399)	 MaxiBlaster Exterior Hardwire Siren (part no. 13-046)	 Keychain Touchpad (part no. 60-694-01-43)	 Door/Window & Magnet Sensor (part no. 60-670-01-43)
 Door/Window & Magnet Spacers (2 Pack) (part no. 60-827)	 Door/Window Sensor Hardwire Kit (part no. 60-826)	 Family SAFETY & SECURITY Fingerprint Kit <small>INCLUDES SAFETY TIPS, IDENTIFICATION FILE AND FINGERPRINT INK</small> Finger Print Kit (part no. 466-1466)	

Installing and Programming Additional Sensors, Modules, and Kits

Phone/Pager Dialer

The phone/pager dialer is a powerful device that enables you to program your system to call up to four designated phone or pager numbers that alert you to emergency conditions when you are not home. The phone/pager dialer also enables you to use several other features. For example, if you turn the Latchkey feature on, your security system will call you if your child doesn't arrive home and disarm your system by the programmed Latchkey time.

To Install the Phone/Pager Dialer:

1. Unplug control panel from outlet and remove 9-Volt battery to completely power down the system.

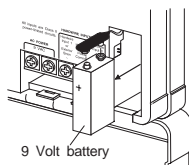

2. Remove the control panel from the table base. Do not completely remove screws from base (see page 13 for details) and turn the panel upside down.

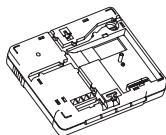

3. Push phone/pager dialer into place on back of control panel making sure that it is flush as shown.

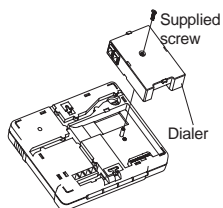

4. Tighten with supplied screw.
5. Plug one end of the phone cord provided into the slot on the phone/pager dialer marked "Phone Line." Plug the other end of the cord into your telephone jack. DO NOT plug a telephone into your control panel.

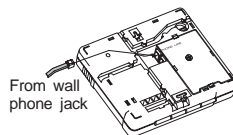

Note

If you want to have both the dialer and a phone connected to the same telephone jack you must purchase a dual phone jack (available at most electronic stores).

6. Slide control panel back onto table base and tighten mounting screws.
7. Replace the control panel battery and plug transformer into outlet.
8. Set the clock time ([see page 3](#)).

Programming Options 3 through 9

Options 3-6 allow you to program up to four different phone or pager numbers into your system. Depending on the type of emergency, your system can call the programmed number(s) to alert you, neighbors, or relatives of a problem when you are away from home.

Note

Do not program your home phone number, 911, or any other public emergency system number into the control panel.

Note

Your phone/pager dialer cannot distinguish between a person answering or an answering machine. The phone/pager dialer will assume a person has answered the call.

Options 3 and 4 allow you to program the control panel with the phone or pager numbers to be automatically called in the event of an intrusion, emergency, or smoke alarm. Each option may contain one phone or pager number.

Options 5 and 6 allow you to program the control panel with the phone or pager numbers to be automatically called to report an AC power failure or restoral (Option 7 must be on) and a Latchkey alarm (Option 8 must be programmed and Latchkey feature enabled). Each option may contain one phone or pager number.

Option 7 (Report AC Power Failure) tells the phone/pager dialer (when Option 7 on) to automatically call the number(s) programmed in Options 5 and 6 when AC power to your home is lost and call again when the power is restored.

Note

The control panel backup battery must be attached and charged for the dialer to call numbers during an AC power failure.

Option 8 (Set Latchkey Time) sets the Latchkey alarm time. If Latchkey feature is enabled and, for example, your child does not disarm your security system by the programmed Latchkey time, your system will call the number(s) programmed in Options 5 and 6.

Note

The clock time must be set for the Latchkey feature to work.

Option 9 (Record Message) records a 12-second message, customized depending on the phone/pager numbers you programmed. For example, if you program your system to call your voice pager, your message could say, "Hello. Your security system is reporting a problem."

Note

You must have the phone/pager dialer installed in order to program options 3 through 6.

To add or change Options 3 - 6:

1. **Open control panel cover.**
2. **Press Add** button under START MENU.
3. **Press Option #** button under MAIN MENU until you hear *Option 3* or *Option 4* for intrusion, fire, or emergency alarm reports or *Option 5* or *Option 6* for AC failure and Latchkey alarm reports.
4. **Enter the phone or pager number** using the red numbered keys.

Phone

- For tone dialing just enter the number.
- For pulse dialing **enter 0 0** before entering a phone number.

Pager

- Enter 0 1** before entering the pager number.
- Or, if after testing the pager number is not called, delete the phone number and**
- Enter 0 2** before entering pager number, then add two trailing pauses by **Pressing Sensor Test twice.**
- 5. **Press DONE** button.

Panel voice repeats the phone number you entered.

6. **Repeat** steps 2-4 to program another phone/pager number (up to four total).
7. **Close control panel cover.**
8. **Test dialer** (see instructions on this page).

To program Option 7, Report AC Power Failure:

1. **Open control panel cover.**
2. **Press Add** button under START MENU.
3. **Press Option #** button under MAIN MENU until you hear *Option 7*.
4. **Press DONE** button.

Panel voice announces *Option 7 is on*.

5. **Close control panel cover.**

To program Option 8, Latchkey Time:

1. **Open control panel cover.**
2. **Press Add** button under START MENU.
3. **Press Option #** button under MAIN MENU until you hear *Option 8*.
4. **Press Hours** and **Minutes** buttons to set time.
5. **Press DONE** button.

Panel voice announces the time you set.

6. **Close control panel cover.**
7. **Press ARM Door & Windows** button **once**, then **Press ARM Motion Sensors** button **twice** to enable Latchkey feature.

To program Option 9, Record Message:

1. **Open control panel cover.**
2. **Press Add** button under START MENU.
3. **Press Option #** button under MAIN MENU until you hear *Option 9*.
4. **Press DONE** button.
5. **Begin recording** your 12 second message at the tone.
6. **Press DONE** button.

Panel voice replays your recorded message.

7. **Close control panel cover.**

To delete any option 1 - 9:

1. **Open control panel cover.**
2. **Press Delete** button from START MENU.
3. **Press Option #** button until you hear the option you want to delete.
4. **Press DONE** button.

Panel voice announces *Option # deleted*.

5. **Close control panel cover.**

Phone/Pager Dialer Alarm Phone Reports

Via Phone

If you have programmed your system to alert you of problems via phone, your system calls to deliver the following reports based on the system problem:

- <Sensor Name> Smoke Sensor Alarm*, Message you recorded. A smoke sensor is triggered.

- Intrusion Alarm*, Message you recorded. A door/window sensor is tripped.
- Emergency Alarm*, Message you recorded. Emergency button on touchpads, carbon monoxide sensor, freeze sensor, or water sensor is triggered.
- Latchkey Alarm*, Message you recorded. Latchkey alarm is triggered.
- AC Power Failure*, Message you recorded. Power failure occurs.
- AC Power OK*, Message you recorded. Power is restored to your system.

Via Pager

If you have programmed your system to alert you of problems via a pager, your system pages you to deliver the following numeric reports based on the system problem:

- 666 666** - A smoke sensor is triggered.
- 555 555**- A door/window sensor is tripped.
- 444 444** - Emergency button on touchpads, carbon monoxide sensor, freeze sensor, or water sensor is triggered.
- 333 333**- Latchkey alarm is triggered.
- 222 222**- Power failure occurs.
- 111 111**- Power is restored to your system.

Note

If you disarm your system immediately after an alarm is triggered, your phone/pager dialer will not call the programmed numbers.

Test Dialer

Intrusion/Emergency/Smoke Alarm- Press the red emergency button on the keychain touchpad. Let the panel siren continue for 1 minute allowing the dialer time to call the numbers. End the alarm and verify that the numbers programmed in options 3 and 4 were called.

Latchkey Alarm- Make sure that the latchkey feature is enabled by pressing the ARM Motion Sensors button twice on the control panel. Allow the latchkey time to expire. Wait 1 minute allowing the dialer time to call the numbers. Verify that the numbers programmed in options 5 and 6 were called.

If a test was unsuccessful go through the programming steps a second time.

Remote Handheld Touchpads

Besides your control panel and keychain touchpads, you can use remote handheld touchpads to operate your security system and control individual system lights. A handheld touchpad allows you to operate your security system and system-control lights from convenient locations around your home, such as your backyard or bedside. See page 15 for ordering information.

To program a handheld touchpad into control panel:

1. **Open control panel cover.**
2. **Press Add** button from START MENU.
3. **Press Sensor/Remote** button from MAIN MENU until you hear *Touchpad remote*.
4. **Press and Hold Red Emergency** button on handheld touchpad until touchpad beeps.

Panel announces *Touchpad remote sensor programmed*.

5. **Test sensor.** (See page 29 for testing information.)
6. **Close control panel cover.**

To delete a handheld touchpad from control panel:

1. **Open control panel cover.**
2. **Press Delete** button from START MENU.
3. **Press Sensor/Remote** button until you hear *Touchpad remote sensor*.
4. **Press DONE** button.

Panel announces *Touchpad remote sensor deleted*.

5. **Close control panel cover.**

To Mount Bracket on Wall:

The remote handheld touchpad comes with a wall mounting bracket. To mount to a wall follow the figure to the right.

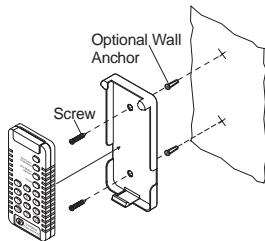

Arm Doors & Windows

Press this button once to turn security system protection on for all doors and windows with sensors. The button lights and the panel voice announces *<Any open sensors>*, beeps, then says, *Doors and windows on*. The 30-second exit delay begins now.

Disarm

Press this button once to turn off security protection. Enter access code if programmed, the button lights, the panel beeps, and announces *System disarmed*, signaling that the system is disarmed.

Lights On

Press this button twice quickly to turn all system-controlled lights on. The panel will announce *Lights <number> on*. You may turn specific lights on by pressing this button once, then using the numeric buttons to enter an individual X-10 unit number. For example, press **Lights On** then **2** to turn all lights set to unit number 2 on.

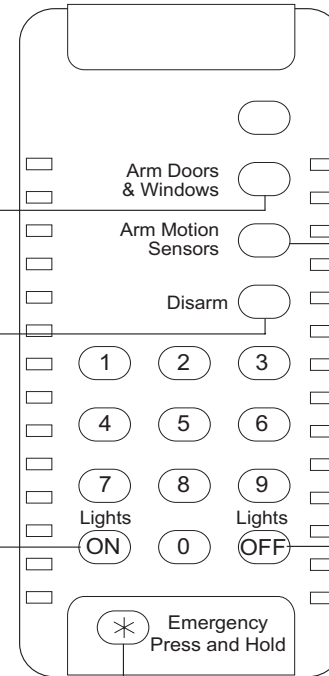

Arm Motion Sensors

Press this button once to turn protection on for all intrusion motion sensors.* This function is usually used in combination with **Arm Doors & Windows**. The panel voice announces *<Any open sensors>*, beeps, then says *Motions on*. The 30-second exit delay begins now. **Press this button twice** to enable the Latchkey feature.**

*Requires motion sensor accessory. See page 15 to order.
**Requires dialer accessory. See page 15 to order.

Emergency

Press and hold this button for three seconds to sound alarms, turn on controlled lights, and call pre-programmed phone numbers.* The panel siren beeps rapidly and system controlled lights turn on. Press the Disarm button and enter code (if programmed) to cancel emergency alarm.

*Requires dialer accessory. See page 15 to order.

Lights Off

Press this button twice quickly to turn all system-controlled lights off. The panel will announce *Lights <number> off*. You may turn specific lights off by pressing this button once, then using the numeric buttons to enter an individual X-10 unit number. For example, press **Lights Off** then **2** to turn all lights set to unit number 2 off.

Indoor Motion Sensors

Indoor motion sensors, which sense the infrared energy emitted from a body as it moves across the sensor field of view, may be used for intrusion protection or to sound special chimes from the control panel when your system is not armed.

To program an indoor motion sensor into control panel:

1. **Remove back** from indoor motion sensor by pressing tab on top and pulling back off.

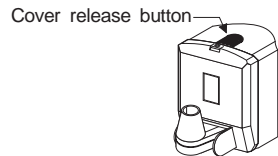

2. **Open control panel cover.**
3. **Press Add** button from START MENU.
4. **Press Sensor/Remote** button from MAIN MENU until you hear the panel announce the name you want associated with the sensor.
5. **Press Program button on back of motion sensor.**

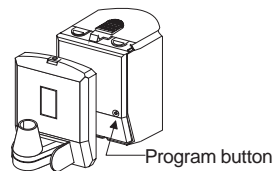

Panel voice announces <Sensor name> motion sensor programmed.

6. **Close control panel cover.**
 - You can also program indoor motion sensors to sound a special chime. If motion sensors are programmed as *Special Chime*, they are not used for intrusion protection.
7. **Label the sensor** (with programmed name) using tape and a pen.
8. **Replace cover.**

To delete an indoor motion sensor from control panel:

1. **Open control panel door.**
 2. **Press Delete** button from START MENU.
 3. **Press Sensor/Remote** button from MAIN MENU until you hear the name associated with the motion sensor you want to delete.
 4. **Press DONE** button.
- Panel announces <Sensor name> motion sensor deleted.
5. **Close control panel door.**

Installation Tips

Do:

- Locate sensors within 100 feet of control panel if possible.
- Mount sensors from 5 to 8 feet high (recommended height: 7 1/2 feet). Higher mounting provides better range (35 feet by 40 feet); lower mounting provides better protection close to motion sensor.
- Position sensors to protect area where an intruder would most likely walk across the detection area.
- Mount motion sensors on insulated outside walls facing in. Mount on rigid surfaces free from vibrations.
- Position sensors so they face a solid reference point such as another wall. Mount sensors permanently; do not set them on a shelf.

Do not:

- Aim motion sensors at windows, fireplaces, air conditioners, area heaters, or forced air heating vents.
- Place motion sensors in direct sunlight. Sudden changes in temperature may trigger a false alarm.

Note

Motion sensors are not recommended in areas where pets are present. Pets *will* trigger a motion sensor.

To Install Indoor Motion Sensors:

1. Mark screw locations through mounting bracket.

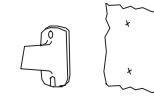

2. Secure mounting bracket to the wall using the two wall anchors and two medium screws provided. Be sure the opening for the swivel assembly points down.

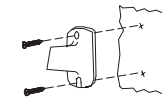

3. Use the long screw provided to fasten the swivel assembly to the mounting bracket.



4. Snap the sensor body onto the mounted swivel assembly.



5. Test sensor. (See page 29 for testing information.)

Outdoor Motion Sensors

Outdoor motion sensors detect motion in an outdoor area but are not used to provide intrusion protection. They are meant only to sound a special chime or to turn on a sensor activated light when triggered. You can program outdoor motion sensors to alert you when a car approaches your driveway or a person enters a pool area, for example.

Note

Because passing cars, people, and animals would trigger an alarm, outdoor motion sensors are not used for intrusion protection.

To program an outdoor motion sensor into control panel:

1. **Pull off outer cover.**

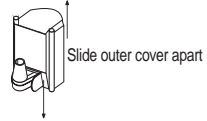

2. **Remove back from motion sensor** by pressing tab on top and pulling back off.



3. **Open control panel cover.**
4. **Press Add** button from START MENU.
5. **Press Sensor/Remote** button from MAIN MENU until you hear *Special chime*.
6. **Press program button on back of motion sensor.**



Panel voice announces *Special chime motion sensor programmed*.

7. **Close control panel cover.**
8. **Label the sensor** (with programmed name) using tape and a pen.
9. **Replace back and outer cover.**

To delete an outdoor motion sensor from control panel:

1. **Open control panel cover.**
2. **Press Delete** button from START MENU.
3. **Press Sensor/Remote** button until you hear *Special chime motion sensor deleted*.
4. **Press DONE** button.

Panel voice announces *Special chime motion sensor deleted*.

5. **Close control panel cover.**

Installation Tips

- Make sure you use outdoor motion sensors with the weather-resistant case.
- Mount sensors from 5 to 8 feet high (recommended height: 7 1/2 feet). Higher mounting provides better range (35 by 40 feet); lower mounting provides better protection close to motion sensor.
- Position sensors to protect areas where a person would most likely walk across the detection area.
- Mount motion sensors on a rigid surface free from vibrations.
- Mount sensors permanently; do not set them on a shelf.
- Since outdoor sensor housing is water-resistant but not water-proof, mount sensors underneath eaves or porch coverings to prevent over exposure to rain and ice. Do not aim motion sensors at objects that may be heated excessively by the sun. This includes black top, dark foliage, shrubbery, and other dark objects. Sudden changes in temperature may trigger the sensor.

To Install Outdoor Motion Sensors:

1. Mark screw locations through mounting bracket.

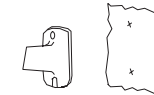

2. Secure mounting bracket to the wall using the two wall anchors and two medium screws provided. Be sure the opening for the swivel mount assembly points down.

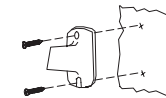

3. Attach the swivel assembly to the mounting bracket using the long screw provided.

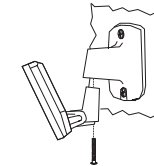

4. Place the sensor into the front piece of an outdoor cover.

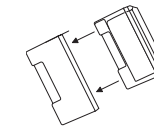

5. Slide the sensor and front cover onto the mounted rear cover plate and swivel assembly.

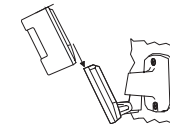

6. Test sensor. (See page 29 for testing information.)

Smoke Sensors

Smoke sensors sound their built-in sirens when smoke is detected. They will also sound the control panel siren and any powerhorn or maxiblaster sirens* you have installed and will cause system-controlled lights to turn on. When you are not home, smoke sensors can notify you via phone or pager using the phone/pager dialer.*

*Additional accessory. See page 15 for ordering information.

Locate a smoke sensor on each level of your home and between the sleeping area and the rest of the family living unit. In family living units with more than one sleeping area, locate a smoke sensor in each area.

Note

Smoke sensors will detect problems when triggered and will alert you even when your system is disarmed.

To program a smoke sensor into control panel:

1. **Open control panel cover.**
2. **Press Add** button from START MENU.
3. **Press Sensor/Remote** button from MAIN MENU until you hear the panel announce the name you want associated with the smoke sensor.
4. **Press "Test"** button on smoke sensor.

Panel voice announces <Sensor name> smoke sensor programmed.

5. **Close control panel cover.**
6. **Label sensor** (with programmed name) using tape and a pen.

To delete a smoke sensor from control panel:

1. **Open control panel cover.**
2. **Press Delete** button from START MENU.
3. **Press Sensor/Remote** button from MAIN MENU until you hear the name associated with the smoke sensor you want to delete.
4. **Press DONE** button.

Panel voice announces <Sensor name> smoke sensor deleted.

5. **Close control panel cover.**

Installation Tips

- Mount all smoke sensors within 100 feet of the panel.
- Install a minimum of two smoke sensors in any household, no matter how small it is.
- Put a smoke sensor in the hallway outside of every bedroom area. A minimum of two sensors are required in homes with two bedroom areas.

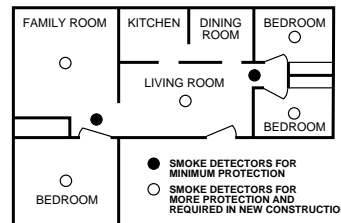

- Put a smoke sensor on every level of a multilevel residence.
- Install basement sensors on the ceiling at the bottom of the basement stairwell.

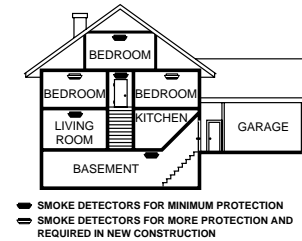

- Install sensors on the ceiling as close to the center of the room as possible. If this is not practical, install it on the ceiling no closer than 4 inches from any wall or corner.
- If ceiling mounting is not practical, install sensors on an inside wall between 4 and 6 inches from the ceiling.
- Put sensors at both ends of a bedroom hallway if the hallway is more than 30 feet long. Large rooms over 900 square feet require more than a single sensor.

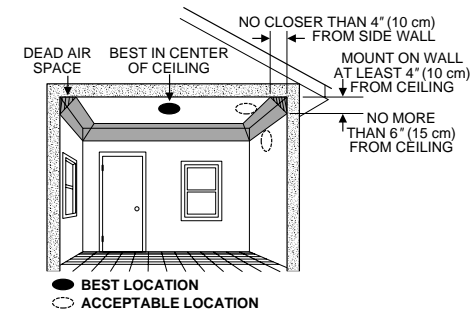

- Areas with rough ceilings or short, transom-type walls coming down from the ceiling require additional sensors.
- Install second-floor sensors on the ceiling at the top of the first-to-second floor stairwell. Be sure no door or other obstruction blocks the path of smoke to the sensor.
- In rooms with sloped, peaked, or gabled ceilings, install sensors 3 feet measured down on the slant from the highest point of the ceiling.

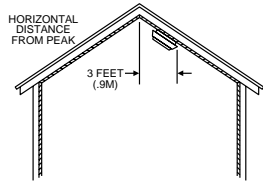

To Install Smoke Sensors:

1. Twist off base (counterclockwise) from smoke sensor body.
2. Hold base up to ceiling and mark with a pencil where the screw mounting holes are.

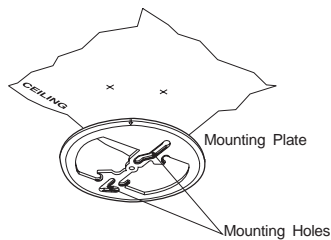

3. Line up base with marks on ceiling.
4. Secure base to ceiling with screws provided.

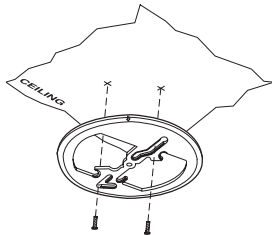

5. Align arrow on base to notch on body.

6. Twist body (clockwise) back onto mounted base.

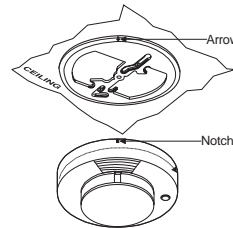

7. Test sensor. (See page 29 for testing information.)

Carbon Monoxide Sensors (CO Sensors)

Gas appliances, such as water heaters, furnaces, clothes driers, and ranges, produce carbon monoxide (CO) gas. If appliances are not working properly, dangerous levels of CO can build up, especially in winter when houses are tightly sealed. Your CaretakerEZ CO sensor alerts you to dangerous levels of carbon monoxide gas in your home by sounding its siren, the siren on the control panel, and any powerhorn or maxiblaster sirens* you have installed. When you are not at home, CaretakerEZ CO sensors can notify you via phone or pager using the phone/pager dialer accessory.*

Note

CO sensors will detect problems when triggered and will alert you even when your system is disarmed.

*Additional accessory. See page 15 for ordering information.

To program a CO sensor into control panel:

1. **Unplug CO sensor** (if you plugged it in).
2. **Open control panel cover.**
3. **Press Add** button from START MENU.
4. **Press Sensor/Remote** button from MAIN MENU until you hear the panel announce the name you want associated with the sensor.

Note

Hold one hand over the siren vent while holding test button since the siren noise is very loud.

5. **Plug CO sensor into any outlet** (you can re-locate the sensor to its operating outlet once you are done programming).
6. **Press “TEST/RESET” button** on CO sensor for 8 beeps within 30 seconds of plugging CO sensor in.



Panel announces <Sensor name> emergency sensor programmed.

7. **Close control panel cover.**
8. **Label the sensor** (with programmed name) using tape and a pen.
9. **Plug CO sensor** into the outlet where you want the unit located.

To delete a CO sensor from control panel:

1. **Open control panel cover.**
2. **Press Delete** button under START MENU.
3. **Press Sensor/Remote** button from MAIN MENU until you hear the name associated with the CO sensor you want to delete.
4. **Press DONE** button.

Panel announces <Sensor name> emergency sensor deleted.

5. **Close control panel cover.**

Installation Tips

Warning!

Install CO sensors only in outlets that are not controlled by a switch because the CO sensor alarm will fail to warn occupants of dangerous gas levels if the outlet switch is turned off accidentally. The CO sensor measures the carbon monoxide gas levels only at its installed location. Dangerous gas levels could still be present in other areas.

Do:

- Install CO sensors near bedrooms and on each level of the building including the basement.

Do not:

- Install above or below heating vents.
- Install above cooking surfaces or within 5 feet of open-flame appliances.
- Install next to windows, exterior doors, or in locations where furniture or draperies may block the unit.
- Install near automobile exhaust pipes (this will damage your CO sensor).

To Install CO Sensor:

1. Plug the CO sensor into the lower socket of an electrical outlet at the desired location. The green power light should turn on. Allow one hour after plugging it in for the CO sensor to initialize and begin monitoring CO gas levels.
2. Test CO sensor. Wait at least 10 minutes after installation to test.

See [Troubleshooting Table](#) if sensor test fails.

CO Sensor Operations:

- Green light indicates ON or normal condition.
- Red light indicates ALARM condition. This means the CO sensor is currently sensing hazardous levels of CO. The internal siren sounds while hazardous levels of CO are present, but may be silenced for 7 to 9 minutes by pressing the RESET button. **The area should be ventilated and all people and animals evacuated immediately.**

In the Event of a CO Emergency:

1. Evacuate the premises immediately.
2. Account for all occupants.
3. Call the fire department from another location. Do not re-enter the building until the source of carbon monoxide has been located and the problem is corrected by a qualified technician.

Warning!

Gases not detected by your CO sensor: Methane, Butane, Heptane, Ethyl Alcohol, Isopropyl Alcohol, Carbon Dioxide, Propane.

Freeze Sensors

If you live in a cold climate, a freeze sensor can be an important part of your system. When the temperature in your home falls to 41 degrees F, your system can alert you to a furnace failure before pipes freeze. If your freeze sensor is triggered, it restores itself when the temperature rises to 50 degrees F.

Note

Freeze sensors will detect problems when triggered and will alert you even when your system is disarmed.

To program a freeze sensor into control panel:

1. **Remove cover** from freeze sensor by pressing tab and lifting cover off.
2. **Open control panel cover.**
3. **Press Add** button from START MENU.
4. **Press Sensor/Remote** button from MAIN MENU until you hear the panel announce the name you want associated with the sensor.
5. **Press** "Press to program" button on freeze sensor.

Panel announces <Sensor name> freeze sensor programmed.

6. **Close control panel cover.**
7. **Label the sensor** (with programmed name) using tape and a pen.

To delete a freeze sensor from control panel:

1. **Open control panel cover.**
2. **Press Delete** button from START MENU.
3. **Press Sensor/Remote** button from MAIN MENU until you hear the name associated with the freeze sensor you want to delete.
4. **Press DONE** button.

Panel announces <Sensor name> freeze sensor deleted.

5. **Close control panel cover.**

Installation Tips

- ❑ **Screw installation is strongly recommended.**

Do:

- ❑ Place sensor within 100 feet of the panel.
- ❑ Locate sensor in an area that is likely to get cold first.
- ❑ Locate the sensor on an interior wall where there is unrestricted air movement.
- ❑ Program and test sensor before permanently mounting it.
- ❑ Mount sensor to a clean, dry, nonporous surface.

Do not:

- ❑ Locate the sensor in same room as furnace, water heater, or any other heat source that may stay warm after the furnace fails.
- ❑ Mount the sensor on an outside wall or near the basement floor.
- ❑ Mount the sensor in areas with excessive metal or electrical wiring.
- ❑ Mount the sensor where it will be exposed to moisture.

To Install Using Screws:

1. Remove freeze sensor outer cover by pressing the button on the end of the sensor.
2. Remove the batteries from the sensor to access the screw mounting holes. Mark screw locations on mounting surface through mounting holes.

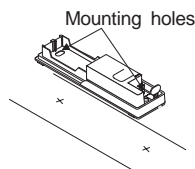

3. Use a 3/32-inch sized drill bit to drill 1/2-inch deep holes where you made the marks.

Note

It is not necessary to drill holes before installing however, it may prevent cracking of woodwork.

4. Secure the sensor base to the mounting surface using the short #4 screws provided. If mounting on plaster, use the appropriate fasteners. Use the slotted mounting hole for alignment.

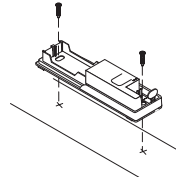

5. Replace batteries and the sensor outer cover.
6. Test sensor. (See page 29 for testing information.)

To Install Using Tape:

Caution

Mount sensors with screws whenever possible. The usually damp locations where freeze sensors may be mounted could effect the adhesiveness of the tape.

1. Using scissors, cut double sided tape in half.
2. Apply double-sided tape to sensor base.

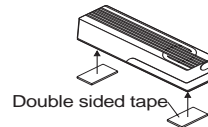

3. Attach sensor to a clean, dry surface.

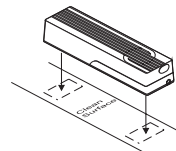

4. Test sensor. (See page 29 for testing information.)

Water Sensors

Water from broken water lines, leaky water heaters, or failed sump pumps can cause extensive and expensive damage to your home. And, the longer the water trouble goes unnoticed, the more extensive the damage. With water sensors, your system can immediately alert you when rising water or leaks are detected inside your home.

Note

Water sensors will detect problems when triggered and will alert you even when your system is disarmed.

Caution

Do not place the *transmitter* in an area where it will get wet. Doing so will damage the sensor. Place the *detector* in the area that will get wet first.

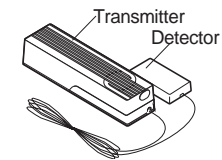

To program a water sensor into control panel:

1. **Remove** cover from water sensor (transmitter) by pressing tab and lifting off cover.
2. **Open control panel cover.**
3. **Press Add** button from START MENU.
4. **Press Sensor/Remote** button from MAIN MENU until you hear the panel announce the name you want associated with the water sensor.
5. **Press** "Press to Program" button on water sensor (transmitter).

Panel announces <Sensor name> water sensor programmed.

6. **Close control panel cover.**
7. **Label the sensor** (with programmed name) using tape and a pen.

To delete a water sensor from control panel:

1. **Open the control panel cover.**
 2. **Press Delete** button from START MENU.
 3. **Press Sensor/Remote** until you hear the name associated with the water sensor you want to delete.
 4. **Press DONE** button.
- Panel announces <Sensor name> water sensor deleted.
5. **Close control panel cover.**

Installation Tips

- Screw installation is strongly recommended.**
- Keep the transmitter within 100 feet of the panel.
- Program and test sensor before permanently mounting.
- Water sensors are typically placed in a basement near a sump pump or water heater to alert you to pump failure or pipe leaks.

To Install Using Screws:

1. Remove the water sensor (transmitter) outer cover by pressing the tab on the end of the sensor.
2. Remove the batteries from the sensor (transmitter) to access the mounting holes. Mark screw locations on mounting surface through the mounting holes.

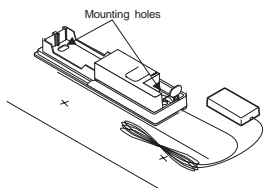

3. Use a 3/32-inch sized drill bit to drill 1/2-inch deep holes where you made the marks.

Note

It is not necessary to drill holes before installing however, it may prevent cracking of woodwork.

4. Secure the water sensor (transmitter) to the mounting surface using the short #4 screws provided. If mounting on plaster, use the appropriate fasteners. Use the slotted mounting hole for alignment.

5. Secure the detector to a clean, dry surface using double-sided tape.
6. Replace batteries and sensor (transmitter) outer cover.

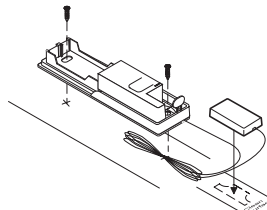

7. Test sensor. (See page 29 for testing information.)

To Install Using Tape:

Caution

Mount sensors with screws whenever possible. The usually damp locations where water sensors may be mounted could effect the adhesiveness of the tape.

1. Using scissors, cut the double sided tape in half.
2. Apply the tape to the sensor (transmitter).

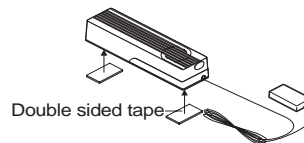

3. Secure the sensor (transmitter) and detector to a clean, dry surface.

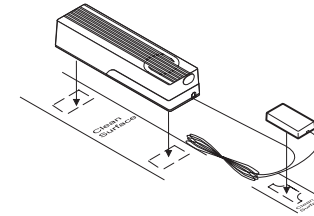

4. Test sensor (See page 29 for testing information.)

X-10 Modules

Your CaretakerEZ system supports a variety of X-10 modules that allow you to control the lights inside your home, operate your garage door, and use remote sirens throughout your home. X-10 lamp and socket rocket modules, as well as powerhorn sirens and the universal/garage door module use the existing electrical wiring in your home to receive signals from the control panel. Since there is little direct wire connection required, X-10 modules can be plugged into available outlets for use with your security system.

X-10 Socket Rockets

Adequate lighting, both indoors and out, is an important part of any security system. In addition to using X-10 lamp modules for connecting indoor lamps to your security system, you can use X-10 socket rocket modules with any lamp or light fixture to control interior and exterior lights with your security system.

Caution

Do not plug appliances into the X-10 socket rocket. Do not use the X-10 socket rocket with lamps that use over 150 watts. Use module with incandescent lamps only.

Note

You need to have a handheld touchpad in order to program X-10 socket rockets. See page 15 for ordering information.

To program an X-10 socket rocket into control panel:

Note

Discard any instructions that come in the X-10 module box.

1. Make sure that light fixture is off.
2. **Screw** X-10 socket rocket into light fixture.
3. **Screw** bulb into X-10 socket rocket.

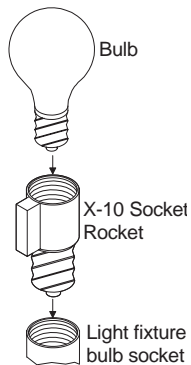

4. **Turn power on** (bulb will not light until socket rocket is programmed).
5. Using the handheld touchpad, **press Lights On button** then **press desired numeric button** (desired unit code). Do this three times within 30 seconds of turning the power on. After pressing the button the third time, the light turns on.

Example: Setting unit code to “3.”

1. Turn power on.
2. Press Lights On button (on handheld touchpad).
3. Press number “3” button (on handheld touchpad).
4. Press Lights On button.
5. Press number “3” button.
6. Press Lights On button.
7. Press number “3” button.
8. Light will turn on.

The socket rocket remains programmed even after the power is removed so you can program it into the control panel from any convenient indoor lamp then move the module to its final location which may be in an outside light fixture.

X-10 Universal/Garage Door Modules

With an X-10 universal/garage door module, you can tie your existing garage door opener into your CaretakerEZ system. Once you wire the universal/garage door module to your garage door opener transmitter, you can operate your existing garage door with a CaretakerEZ keychain touchpad.

To program X-10 universal/garage door module into control panel:

Note

Discard any instructions that come in the X-10 module box.

1. **Set the house code** (using a screwdriver) on each X-10 universal/garage door module to the same one you programmed into the control panel. (See [Programming House Code on page 4.](#))
2. **Set** the module switches to “momentary” and “relay only.”
3. **Set the unit number** of the universal module to a unique unit number between 1 and 8. Do not use the same unit number for a universal/garage door module as you do for controlled lights. If you do, your garage door will open when X-10 lamp and socket rocket modules with the same unit number turn on (#8 recommended).

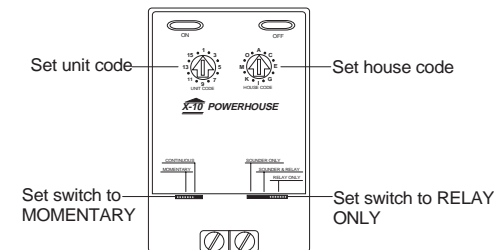

4. **Open control panel cover.**
5. **Press Add** button from START MENU.
6. **Press Light Control** button from MAIN MENU.
7. **Press Unit #** button until you hear the number you set on the X-10 universal/garage door module.
8. **Press Sensors** button from CONTROL MENU until you hear *Keychain remote sensor*.

Panel voice announces *Unit number N activated by keychain remote sensor*

9. **Close control panel cover.**

To delete an X-10 universal/garage door module from control panel:

1. **Open control panel cover.**
 2. **Press Delete** button from START MENU.
 3. **Press Light Control** button from MAIN MENU.
 4. **Press Unit #** button until you hear the unit number you programmed for the universal/garage door module.
 5. **Press Sensors** button from CONTROL MENU until you hear *Keychain remote sensor*.
 6. **Press DONE** button.
- Panel voice announces *Unit number N activated by keychain remote sensor deleted.*
7. **Close control panel cover.**

Installing X-10 Universal/Garage Door Module

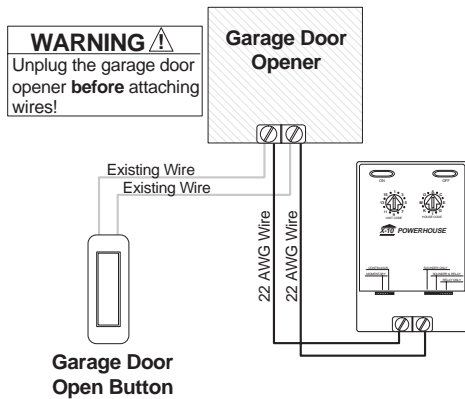

1. Unplug existing garage door opener unit.
2. Connect the terminals on your universal/garage door module to the terminals on the garage door opener using 22-gage wire.
3. Plug the universal/garage door module into an outlet.
4. Plug the garage door opener unit into an outlet.
5. Test the X-10 universal/garage door module by pressing the Star button on your keychain touchpad. (See page 29 for testing information.)

X-10 Powerhorn Sirens

Your control panel has an internal siren that sounds when alarms occur. To supplement the internal siren, you can also use X-10 powerhorn sirens to alert you to alarms and emergencies. As with other X-10 modules, you need only set and program the proper house code (one higher than the house code programmed into the control panel) then plug the X-10 siren into an outlet.

Note
X-10 Powerhorn sirens will only sound in the case of an intrusion or fire alarm.

To program an X-10 powerhorn siren into control panel:

Note
Discard any instructions that come in the X-10 module box.

1. **Set the house code** on the X-10 powerhorn siren to the alphabetical letter that comes *after* the house code you programmed into the control panel. For example, if you programmed B as the house code on the control panel, set the powerhorn siren house code to C. All other X-10 modules should be set to the same house code that is programmed into the control panel.

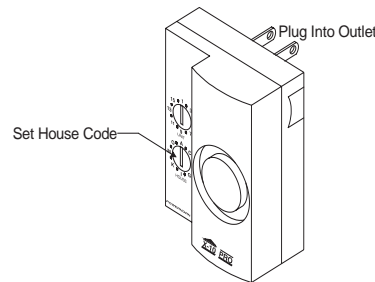

Note
You do not need to set a unit number.

MaxiBlaster Exterior Hardwire Siren

You can hardwire and mount a MaxiBlaster exterior siren which will sound when an alarm is triggered or other system emergency occurs. An exterior siren can help force an intruder to quickly retreat from your home.

Note
Only one hardwire exterior siren may be connected to your system.

Note
Maxiblaster sirens will only sound in the case of an intrusion or fire alarm.

To install a MaxiBlaster hardwire siren:

1. Follow the corresponding diagram below.

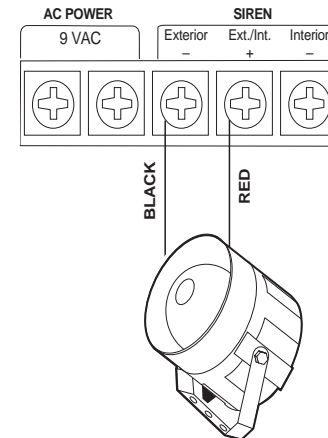

Door/Window Sensor Hardwire Kits

In some cases you may want to mount door/window sensors in less visible areas using hardwire contacts and terminal blocks. The hardwire kit will also aid in mounting door/window sensors to difficult window designs.

To Connect a Wireless Sensor with the Hardwire Kit:

Note

You will need a hardwire kit, Phillips screwdriver, small flathead screwdriver, stranded 22-gauge wire (not included with kit), and small wire cutters.

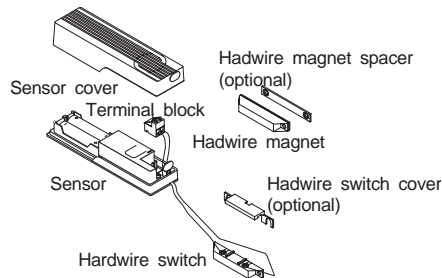

Caution

Read through these instructions before beginning the installation.

1. Remove the door/window sensor cover.
2. Use your wire cutters to cut two equal lengths of 22-gauge wire. The wire length must be adequate to cover the distance between the hardwire switch and sensor.
3. Route the two wires up through the square hole in the bottom of the sensor.

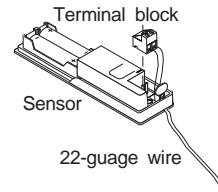

4. Determine the location of the sensor and mount it according to the sensor mounting instructions.
5. Use your flathead screwdriver to loosen the screws on top of the terminal block (do not remove screws). Place one wire into each terminal block as shown. Tighten the screws. Gently tug on the wires to make sure they are securely connected.
6. Slide the terminal block onto the two metal posts. Pull any excess wire out through the bottom hole.
7. Loosen the two screws on the hardwire switch with the Phillips screwdriver and wrap wire around each terminal (under screw head and washer) as shown. Tighten the two screws then gently tug on the wires to make sure they are securely connected.

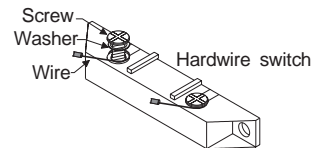

Note

Polarity (which wire goes onto which terminal) is unimportant.

To Mount the Hardwire Sensor:

1. Mount the hardwire switch to the door/window frame. It is at this point you need to decide if you want to use the hardwire switch terminal cover supplied. If so, you may need to use a hardwire magnet spacer (provided).

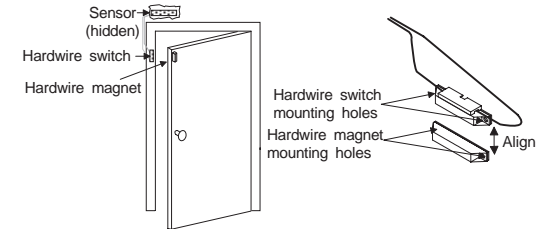

2. Make sure that the hardwire magnet is aligned within 3/8-inch to the hardwire switch and mount it to the door or window.
3. Test sensor, then replace sensor cover. (See page 29 for testing information.)

Finger Print Kits

The finger print kit is an important tool in helping you safeguard your children and family in the event of an emergency. The kit is designed to provide you and authorities with a fingerprint record, current photo, and other important information. The most important feature is that it gives you the opportunity to talk about safety with your children.



Sensor and X-10 Module Testing

Immediately after installing a sensor or module you should test it. And once the system is up and running, you should perform tests regularly to make sure your system is working and properly protecting your home.

You can test sensors and modules one at a time to make sure they are sending strong signals to the control panel.

To Test Sensors:

1. Open control panel cover.
2. Press Sensor Test button from START MENU. The panel announces, one at a time, the sensors you have programmed.
3. “Trip” sensors one at a time. You can trip them in any order; you do not have to trip sensors in the order the control panel announces them. When you trip a sensor and it communicates successfully, that sensor will be removed from the announced list. Use the Sensor Testing Table on the right for testing instructions. The panel voice announces *Sensor test OK* after all sensors have been successfully tested.
4. Press DONE button if any sensors did not test successfully or you want to terminate the test. The panel voice announces *Sensor test canceled or failure*. If a sensor test fails, see [Troubleshooting Table](#).
5. Close control panel cover.

To Test X-10 Modules:

1. Test X-10 modules one at a time. Use the Sensor Testing Table on the right for testing instructions. If a module fails to respond to the test, see the [Troubleshooting Table](#).

Sensor Testing Table

Sensor	Do This to Trip Sensor(s)
Door/Window	Open the door or window you want to test.
Freeze Sensor	Apply ice in a plastic bag to the sensor.
Water Sensor	Press a wet rag or wet finger over both of the round, gold-plated terminals on the underside of the detector.
Carbon Monoxide Sensor	Press and hold the TEST/RESET button until the unit beeps twice.
Motion Sensor	Avoid the Motion Sensors view for 4 minutes, then enter its view.
Smoke Sensor	Press and hold the test button until the system beeps.
Handheld Touchpad	Press and hold the red button for 3 seconds on the handheld touchpad you want to test.
Keychain Touchpad	Press and hold the red button for 3 seconds on the keychain touchpad you want to test.
X-10 Modules	
X-10 Lamp Module	Press and hold the Lights button on the keychain touchpad. The lamp should turn on/off.
X-10 Socket Rocket	Press and hold the Lights button on the keychain touchpad. The light should turn on/off.
Garage Door Opener	Press and hold the Star button on the keychain touchpad. (Must be properly programmed, see page 26 for details.)
Sirens	Simulate an alarm by arming your system, allowing the exit delay to expire, opening a protected door, and letting the entry delay expire (which places the system into alarm).

Battery Life and Replacement

Use the Battery Replacement Table below for replacing old batteries. You may purchase batteries at www.ezsecurity.com or a store. Your control panel will announce any low batteries and their associated sensor.

Accessory	Average Life	Replacement Battery(s)	*Part No.
Batteries may be ordered on the web at www.ezsecurity.com using the provided part no.*			
Control Panel	1 Year (without AC failure)	1—9Volt Lithium	60-713
Door/Window	3-5 Years	2—1.5-VDC AAA Alkaline	60-710
Keychain Touchpad	5-8 Years (depending on use)	1—12Volt Alkaline NEDA	60-825
Remote Handheld Touchpad	3-5 Years (depending on use)	2—1.5-VDC AAA Alkaline	60-710
Motion Sensors	2-4 Years (depending on use)	2—1.5-VDC AA	60-600
Smoke Sensor	Replace Every Year	2—9Volt Alkaline	60-814
Freeze Sensor	3-5 Years	2—1.5-VDC AAA Alkaline	60-710
Water Sensor	3-5 Years	2—1.5-VDC AAA Alkaline	60-710

Troubleshooting

Problem	Solution
I don't understand the SYSTEM STATUS indicator or I can't clear the SYSTEM STATUS.	<ul style="list-style-type: none"> <input type="checkbox"/> Press SYSTEM STATUS button to hear current status. If it is on, press to hear current status. If it is flashing, an alarm has occurred. Press to identify tripped sensor(s). <input type="checkbox"/> Clear SYSTEM STATUS by pressing DISARM.
My system is reporting an AC power failure.	<ul style="list-style-type: none"> <input type="checkbox"/> Your security system has been accidentally unplugged or there has been an AC power outage. Make sure your system is plugged into a working outlet. <input type="checkbox"/> Press SYSTEM STATUS button to confirm the AC power failure. The back-up battery, if fully charged, will power your security system for 24 hours with no AC power. <p>Note Your system should not be plugged into a ground fault outlet or an outlet controlled by a switch. If your AC power is out, the back-up battery will take over.</p>
My system is reporting a system low battery.	<ul style="list-style-type: none"> <input type="checkbox"/> The emergency back-up battery has been drained or disconnected from your system. The SYSTEM STATUS button will light. Press SYSTEM STATUS button to hear the trouble message. If your AC power is not working, your security system will shut down once the back-up battery is drained. <input type="checkbox"/> Replace the control panel battery once a year (lithium batteries every two years). The battery will drain over time. A fully-charged battery provides up to 24 hours of protection when the AC power is off.
My system is reporting "sensor low battery."	<ul style="list-style-type: none"> <input type="checkbox"/> A sensor has a low battery. The sensor may still be communicating with your control panel but will eventually lose the battery power needed to communicate. The SYSTEM STATUS button will light. Press SYSTEM STATUS button to hear which sensor(s) have trouble and replace the batteries.
My system is reporting that the system time is not set.	<ul style="list-style-type: none"> <input type="checkbox"/> Set the system time.
My system reports "function not available."	<ul style="list-style-type: none"> <input type="checkbox"/> The function you are trying to enable/disable is not programmed into the system. Please refer to the programming instructions to reprogram the function.
My system reports "Invalid. Sensor already programmed as <Sensor name>" when I try to program a sensor into the control panel.	<ul style="list-style-type: none"> <input type="checkbox"/> This sensor is already programmed into the control panel. Delete the sensor if it is not programmed as you want it and program it into the control panel again.
My control panel does not beep.	<ul style="list-style-type: none"> <input type="checkbox"/> Delete option 1 to turn control panel siren on.
My control panel voice does not respond.	<ul style="list-style-type: none"> <input type="checkbox"/> Delete option 2 to turn control panel voice on.
The latchkey feature does not function.	<ul style="list-style-type: none"> <input type="checkbox"/> Make sure the phone/pager dialer is installed. If the latchkey time (option 8) is not set, set latchkey time. <input type="checkbox"/> The latchkey feature is not enabled. Enable latchkey feature by pressing ARM Motion Sensors twice. <input type="checkbox"/> The phone number is not programmed properly. Reprogram the phone number (options 5 and 6). <input type="checkbox"/> The system clock is not set. Set system time.
A sensor does not work.	<ul style="list-style-type: none"> <input type="checkbox"/> Test sensor. <input type="checkbox"/> Make sure the battery(s) is working and installed correctly. <input type="checkbox"/> Check for interference from metal objects. Move or rotate the sensor to find a better position. <input type="checkbox"/> Move the sensor to a new location.

Problem	Solution
My control panel reports that a door or window is open when I try to arm the system.	<ul style="list-style-type: none"> <input type="checkbox"/> A door or window is open and the sensor is bypassed when the system is armed. If you do not want the sensor bypassed, disarm your system, close the door or window, then re-arm your system.
My door or window is closed, but the control panel voice announces it is open.	<ul style="list-style-type: none"> <input type="checkbox"/> Open then close the door or window. <input type="checkbox"/> Be certain the arrow on the magnet and the guide line on the transmitter are aligned and are within 3/8-inch of each other.
My motion sensor is triggered continuously.	<ul style="list-style-type: none"> <input type="checkbox"/> Be sure the sensor is mounted on a solid surface and the viewing field is free from sources of changing temperature. <input type="checkbox"/> Be sure pets or items like floating helium balloons or fluttering curtains are not crossing the viewing field.
My motion sensor does not respond to motion.	<ul style="list-style-type: none"> <input type="checkbox"/> Make sure the sensor is properly programmed. (Check by pressing SYSTEM STATUS twice.) <input type="checkbox"/> Make sure the batteries are working and installed correctly. Wait 2 minutes after installing the new batteries to test. <input type="checkbox"/> Adjust the sensor mounting/swivel angle. <input type="checkbox"/> Leave the area for 4 minutes, then retest. <input type="checkbox"/> The environment is too hot or too cold. Outdoor sensors operate between 32° and 120°F. <input type="checkbox"/> Dirt or dust may be causing the problem. Wipe the sensor with a clean, damp cloth.
X-10 Module Troubleshooting	
No lamp modules or sirens are working.	<ul style="list-style-type: none"> <input type="checkbox"/> Be sure that the module is plugged directly into an outlet and that the outlet is not controlled by a wall switch. <input type="checkbox"/> You may have a bad transformer. Call customer assistance. <input type="checkbox"/> Make sure the house code was programmed correctly.
Unscheduled lights are turning on and off.	<ul style="list-style-type: none"> <input type="checkbox"/> Change house code on modules. A neighboring system may be using the same house code.
One lamp module or siren is not working.	<ul style="list-style-type: none"> <input type="checkbox"/> Make sure the lamp has a working bulb. <input type="checkbox"/> Make sure the lamp is plugged into the lamp module, the module is plugged into the outlet, and the outlet is not controlled by a wall switch. <input type="checkbox"/> Make sure the house and unit codes are correct. <input type="checkbox"/> Unplug nearby equipment which may be causing interference (light dimmer switches, televisions, appliances). <input type="checkbox"/> Check that the switch on the lamp or appliance is turned on and remains on. <input type="checkbox"/> Move the module to a different outlet that is on the same phase (branch) of the household electrical circuit as the control panel.
Time-activated or sensor-activated light is not working.	<ul style="list-style-type: none"> <input type="checkbox"/> Make sure you have programmed the light to be activated by a timer or sensor. <input type="checkbox"/> Make sure the system clock is set. <input type="checkbox"/> Make sure these functions have been enabled by pressing the LIGHTS Time Activated/Sensor Activated on the control panel. They are enabled if the button is lit.
My CO sensor can't be programmed into the control panel.	<ul style="list-style-type: none"> <input type="checkbox"/> Make sure the outlet the CO sensor is plugged into is not controlled by a switch. <input type="checkbox"/> Make sure the unit has not been plugged in more than 60 seconds before pressing and holding the test button prior to programming attempt. Unplug your CO sensor for 10 seconds and retry programming. <p>Note If your CO sensor sounds continuous intermittent beeps and the green and red lights flash, the CO sensor is malfunctioning. Call customer assistance.</p>

X-10 Module Information Table

House Code is ____						
Module			Activated by		Time-Activated	
Unit #	X-10 Type	Location	Sensor	Entry/Exit	Start Time	Stop Time
(Ex. 1) 2	<i>Lamp Module</i>	<i>Living Room Lamp</i>	<i>No</i>	<i>Yes</i>	<i>8 p.m.</i>	<i>10:30 p.m.</i>
(Ex. 2) 2	<i>Socket Rocket</i>	<i>Porch Light</i>	<i>Motion</i>	<i>No</i>	<i>NA</i>	<i>NA</i>
1						
2						
3						
4						
5						
6						
7						
8						

FCC Notices

FCC Part 15 Information to the User

Changes or modifications not expressly approved by Interactive Technologies, Inc. can void the user's authority to operate the equipment.

FCC Part 15 Class B

This equipment has been tested and found to comply with the limits for a Class B digital device, pursuant to part 15 of the FCC Rules. These limits are designed to provide reasonable protection against interference in a residential installation.

This equipment generates, uses, and can radiate radio frequency energy and, if not installed and used in accordance with the instructions, may cause harmful interference to radio communications. However, there is no guarantee that interference will not occur in a particular installation.

If this equipment does cause harmful interference to radio or television reception, which can be determined by turning the equipment off and on, the user is encouraged to try to correct the interference by one or more of the following measures:

- Reorient or relocate the receiving antenna.
- Increase the separation between the equipment and receiver.
- Connect the affected equipment and the panel receiver to separate outlets, on different branch circuits.
- Consult the dealer or an experienced radio/TV technician for help.

FCC Part 68

This equipment complies with Part 68 of the FCC Rules. Located on this equipment is a label that contains, among other information, the FCC registration number and the ringer equivalence number (REN) for this equipment. If requested, this information must be provided to the telephone company.

The REN is used to determine the maximum number of devices that may be connected to your telephone line. In most areas, the sum of all device RENs should not exceed five (5.0).

























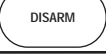

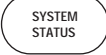

If this equipment causes harm to the telephone network, the telephone company may temporarily disconnect your service. If possible, you will be notified in advance. When advance notice is not practical, you will be notified as soon as possible. You will also be advised of your right to file a complaint with the FCC.

Your telephone company may make changes in its facilities, equipment, operations, or procedures that could affect the proper operation of your equipment. You will be given advanced notice in order to maintain uninterrupted service.

If you experience trouble with this equipment, please contact the company that installed the equipment for service and repair information. The telephone company may ask you to disconnect this equipment from the network until the problem has been corrected or you are sure that the equipment is not malfunctioning.

This equipment may not be used on coin service provided by the telephone company. Connection to party lines is subject to state tariffs.

Quick Reference Table

How to Operate . . .		FROM CONTROL PANEL	FROM REMOTE HANDHELD TOUCHPAD	FROM KEYCHAIN TOUCHPAD
Arm the system – Doors & Windows				
Arm the system – Motion Sensors				
Arm the system – Doors/Windows & Motion Sensors		 	 	 Press twice
Activate the Latchkey feature		 Press Twice	 Press Twice	 Press 3 times
Disarm the system		 + Access Code (If Programmed)	 + Access Code (If Programmed)	
Send an alarm to phone or pager			 Press EMERGENCY button & hold for 3 seconds.	 Press & hold for 3 seconds
Check clock time and short system status				
Check detailed system status		 Press Twice		
Enable Doors to Chime				
Enable Special Motion Chime				
Enable Time Activated Lights				
Enable Sensor Activated Lights				
Open a garage door or turn on special lights			 + Unit #	 (If Programmed)
Toggle lights	<i>Lights on</i>		 Press Twice	 Press & hold
	<i>Lights off</i>		 Press Twice	